

Limit Switches



Proximity Sensors



Photoelectric Sensors



12.1 Sensor Learning Course—Learning Module 23: Limit Switches, Proximity Sensors and Photoelectric Sensors

Overview—Eaton University Training	V8-T12-2
Welcome	V8-T12-4
Sensor Basics	V8-T12-4
Review 1	V8-T12-6
Limit Switches	V8-T12-7
Actuators and Operating Heads	V8-T12-9
Limit Switch Types	V8-T12-12
Review 2	V8-T12-14
Inductive Proximity Sensors	V8-T12-15
Review 3	V8-T12-17
Inductive Proximity Sensor Influences	V8-T12-18
Review 4	V8-T12-20
Capacitive Proximity Sensors	V8-T12-21
Capacitive Proximity Sensor Influences	V8-T12-22
Review 5	V8-T12-23
Photoelectric Sensors	V8-T12-24
Photoelectric Sensor Styles and Uses	V8-T12-26
Modes of Detection	V8-T12-27
Review 6	V8-T12-29
Excess Gain	V8-T12-30
Environment	V8-T12-32
Review 7	V8-T12-32
Sensor Output Circuits	V8-T12-33
Switching Logic	V8-T12-36
Output Timing Modes	V8-T12-37
Review 8	V8-T12-38
Enclosure Ratings	V8-T12-39
IEC Ratings	V8-T12-40
Review Answers	V8-T12-41



For Customer Service in the U.S. call 1-877-ETN CARE (386-2273),
in Canada call 1-800-268-3578.
For Application Assistance in the U.S. and Canada
call 1-800-426-9184.

Limit Switches, Proximity Sensors and Photoelectric Sensors



Contents

<i>Description</i>	<i>Page</i>
Learning Module 23: Limit Switches, Proximity Sensors and Photoelectric Sensors	
Welcome	V8-T12-4
Sensor Basics	V8-T12-4
Limit Switches	V8-T12-7
Actuators and Operating Heads	V8-T12-9
Limit Switch Types	V8-T12-12
Inductive Proximity Sensors	V8-T12-15
Inductive Proximity Sensor Influences	V8-T12-18
Capacitive Proximity Sensors	V8-T12-21
Capacitive Proximity Sensor Influences	V8-T12-22
Photoelectric Sensors	V8-T12-24
Photoelectric Sensor Styles and Uses	V8-T12-26
Modes of Detection	V8-T12-27
Excess Gain	V8-T12-30
Environment	V8-T12-32
Sensor Output Circuits	V8-T12-33
Switching Logic	V8-T12-36
Output Timing Modes	V8-T12-37
Enclosure Ratings	V8-T12-39
IEC Ratings	V8-T12-40
Review Answers	V8-T12-41

Overview—Eaton University Training

Limit Switches, Proximity Sensors and Photoelectric Sensors

Knowledge Powers Success.

It takes knowledge to succeed. But, knowledge doesn't just happen. It's a continuous process of learning. Only lifelong learning allows you to keep in step with a world that is constantly changing.

So, you need to get smarter about learning and explore new ways of thinking. You need to take advantage of new experiences and employ cutting edge technologies.

Assess and develop your talents. Empower yourself to find the answers and solutions of tomorrow.

Learn. Succeed.

Training at Eaton Corporation

Sensor Learning Course

The following pages contain a complete learning course that will take you through the basic operation and application of limit switches, inductive and capacitive proximity sensors, and photoelectric sensors. Whether you're a novice looking to get up to speed fast, or are already experienced in this area and just want to sharpen your skills, this course will be time well spent.

This course is part of the 101 Basics Series from Eaton University Training, a comprehensive series of learning modules covering a wide variety of power and control subjects.

About Eaton University Training

Eaton University Training exists to keep you, our partners, at the cutting edge of technical and professional development. We provide education solutions, promote a learning culture and foster talent development for our employees, channel partners, industry and academia.

We share our knowledge resources in a number of ways: from traditional classroom to paper-based distance learning programs to a complete web-based virtual learning environment at our electronic campus.

Eaton University Training educational programs put you directly on the path to career success. We partner with you to determine your knowledge needs and help you apply what you learned. And we're committed to ensuring that you gain maximum return from your time and investment.

To browse the latest course offerings and register on-line, visit us at EatonUniversity@eaton.com.

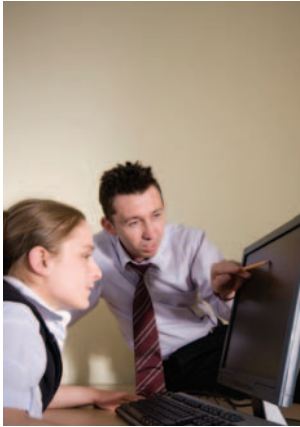

Classroom Interactions

Eaton University Training classroom activities encourage interaction, collaboration and participation. You play an integral role in what happens. Experienced instructors facilitate a learning environment where you can feel comfortable making mistakes and asking questions. The result is a seamless classroom to on-the-job transition that allows you to directly apply your newfound knowledge, making you and your company more productive and competitive.

- Discover product features, benefits and applications in a product technology solutions seminar.
- Gain hands-on experience maintaining electrical equipment or solving simulated power quality problems in one of our state-of-the-art laboratories.
- Become qualified in Information Technology solutions by Eaton, such as Bid Manager or Vista, in a computer training class.
- Collaborate with your peers in one of our talent development workshops.

And it doesn't end there. Eaton University Training offers a full spectrum of personal and professional development options. As new learning needs are identified, our course offerings change to help you meet new challenges.



Virtual Campus

Our virtual campus offers knowledge resources accessible from anywhere in the world, 24 hours a day, and 7 days a week. It's where you go to register for classroom opportunities, participate in on-line learning courses, or search our library for learning tools including educational videos and technical documentation. You control the content, timing and pace of your learning program.

As technology evolves, Eaton University Training commits to giving you access to the most effective learning tools—right from your desktop.

As an Eaton distributor, you can access Eaton University via the Distributor Resource Center on www.eaton.com. Employees can access us on the Eaton University Intranet.

Customized Learning

Can't find what you're looking for? Please contact us. Eaton University Training has course consultants that work with you to customize a class or make recommendations based on your personal needs.

For example:

- Bring a class to your location, saving you time away from the plant or office.
- Customize an existing class, placing emphasis on the subjects your group needs most.
- Receive Eaton University product training outside of the regularly scheduled courses.
- Connect with technical experts who will answer your specific questions.

Start planning your customized learning. E-mail us at EatonUniversity@eaton.com.

We look forward to helping power your success.

Eaton University Training at Eaton Corporation ...

Knowledge Powers Success.

Welcome

Typical Sensors



Welcome to Module 23, which is about **sensors**. As the name implies, **sensors are devices that sense the presence or absence of objects**. Sensors perform a number of functions in automated manufacturing and material handling systems. For example, sensors can determine if an object is present, if tooling is broken, or if product is running down a conveyor line.

This module will take you through the basic operation and application of three major sensor categories: **Limit Switches, Proximity Sensors and Photoelectric Sensors**.

Like the other modules in this series, this one presents small, manageable sections of new material followed by a series of questions about that material. Study the material carefully then answer the questions without referring back to what you've just read. You are the best judge of how well you grasp the material. Review the material as often as you think necessary. The most important thing is establishing a solid foundation to build on as you move from topic to topic and module to module.

A Note on Font Styles

Key points are in **bold**.

12

Sensor Basics

A manual switch enables an operator to interact with a machine. If, for example, an operator sees a problem on a manufacturing line, he could move a switch to stop the line. Or, think of a light switch in your home. If you (the operator) want the light turned on, you have to move the switch.

A sensor can be thought of as an automatic switch. In a factory, a sensor can be used to detect a problem on the line and stop the line automatically. Or, in your home, a sensor could be used as a security device to detect an open window or door.

Sensors have contributed significantly to recent advances in manufacturing technology. Using a sensor makes a process or system more automated and removes the need for human operators to monitor and control the situation.

The three main categories of sensors are limit switches, proximity sensors and photoelectric sensors. Let's take a moment to look at each type of sensor.

Limit Switch

Limit Switch with Standard Roller Lever



A limit switch is an electromechanical device.

A part of the limit switch, called an Actuator, is placed in the path of an oncoming object, such as a box on a conveyor. When the object contacts the actuator, the contacts in the limit switch are opened (or closed, depending on the limit switch's design) to stop (or start) the flow of current in the electrical circuit.

Proximity Sensor

Proximity Sensor Types



This type of sensor uses an electromagnetic field to detect when an object is near.

There is no physical contact between the object and the sensor. Inductive proximity sensors detect only metal objects. Capacitive proximity sensors can sense both metallic and non-metallic objects.

Think of a manufacturing process where the alignment of a part is critical. A proximity sensor can be used to make sure the part is aligned within a certain tolerance. If the part is not properly aligned, the proximity sensor will be triggered.

This type of sensor is generally used to sense at distances less than one inch.

Photoelectric Sensor



This type of sensor uses light to detect the presence or absence of an object.

A **Thru-Beam** photoelectric sensor uses two devices (a light source and a detector) facing each other. Detection occurs when an object blocks or breaks the beam of light passing between them.

Thru-Beam—Beam Complete

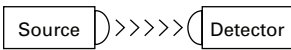

Thru-Beam—Object Detected

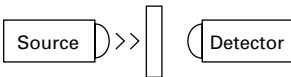

A **Diffuse Reflective** sensor emits a light beam that must be reflected back to it by the target object itself for detection to occur.

Diffuse Reflective—Beam Not Complete

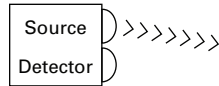

Diffuse Reflective—Object Detected

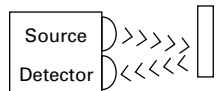

A **Retroreflective Sensing** sensor emits a light beam that is reflected back to the sensor from a retroreflector. When an object blocks the beam between the sensor and the retroreflector, detection occurs. We'll cover more on these types of photoelectric sensors later in this module.

Retro-Reflective/Reflex Mode—Beam Complete

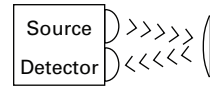

Retro-Reflective/Reflex Mode—Object Detected

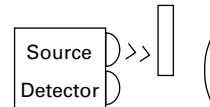

Most electric garage door openers include a photoelectric sensor for safety reasons. If the photoelectric sensor's beam is broken (by a child for example) as the door is going down, the sensor signals the door opener to reverse the direction of the door.

Although environmental factors can affect photoelectric sensors, these devices have a long sensing range. The objects they detect can be of any material.

Sensor Comparison

Each of the three sensor categories has its strengths and weaknesses.

The table below provides you with a comparison.

Sensor Category Comparison

	Limit Switches	Proximity Sensors	Photoelectric Sensors
Method of Detection	Physical contact	Electromagnetic field	Light beam
Sensing Range	Physical contact	Close: within 1 in (25.44 mm)	Far: can be 800 ft (243.8m)
Target Material	Target must be able to withstand physical contact	Inductive: metallic only Capacitive: metallic and non-metallic	Can be affected by target surface, for example, if the target is shiny or transparent
Object Markings	Not able to detect	Not able to detect	Able to detect
Cost	Low	Low	Low to high depending upon sensing method
Sensor Size	Tend to be large	Small to large	Very small (fiber optic) to large
Environmental Sensitivity	Affected by debris	Inductive: electrical interference Capacitive: humidity	Light interference
Response Time	Milliseconds	Milliseconds	Microseconds

In the Workplace

As a conveyor moves the stacked boxes onto a turntable, a sensor detects the boxes in position and tells the machine to start the turntable and index the wrapping material. Another sensor monitors the play out of wrapping material to detect an empty spool and alert set-up personnel. Once the operation ends, the wrapped boxes move on to their shipping destination.

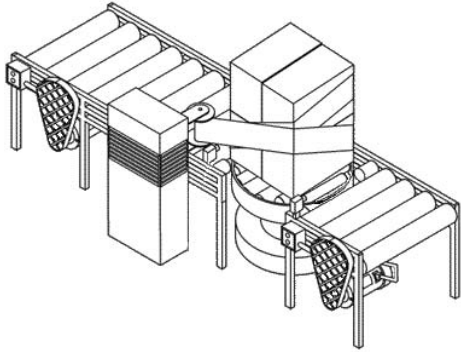

The Sensor “Sees” the Box and Tells the Wrapping Machine to Begin Operating

Thanks to sensors, the repetitive and tedious work done in this factory is handled precisely and reliably by machinery and control systems working together.

Review 1

Answer the following questions without referring to the material just presented. Begin the next section when you are confident that you understand what you’ve already read.

1. Sensors can detect the _____ or _____ of objects.
2. The three main sensor categories are:

3. A limit switch is an _____ device that relies on physical contact with the target.
4. The sensor type that can only detect metallic objects is the _____ sensor.
5. The sensor type that uses a broken beam of light to detect objects is commonly referred to as a _____ sensor.

Answers to Review 1 are on **Page V8-T12-41**.

Limit Switches

Let's now take an in-depth look at the limit switch. It is a commonly used device. If you look around your kitchen, you can find a number of limit switches. For example, limit switches stop your microwave oven from operating unless the door is closed, and they ensure the light in your refrigerator is only on when the door is opened.

Remember, a **limit switch is a mechanical device that requires the physical contact of an object with the switch's actuator to make the contacts change state.** The term limit switch is derived from this operation of the switch. As the object (or target) makes contact with the operator of the switch, it eventually moves the actuator to the "limit" where the contacts change state.

Limit Switch with Adjustable Roller Arm



This mechanical action either opens (in a **Normally Closed [NC]** circuit) or closes (in a **Normally Open [NO]** circuit) the electrical contacts. The contacts then start or stop the flow of current in the electrical circuit.

The switching function can be used to control loads from simple relays to high-current solenoids, from logic devices to PLCs.

Strengths and Weaknesses

As with all devices, the limit switch has its strengths and weaknesses:

Limit Switch Attributes

Attributes

Strengths

Can be used in almost any industrial environment because of its rugged design

Can switch high inductance loads up to 10 amps

Very precise in terms of accuracy and repeatability

Low cost

Weaknesses

Moving mechanical parts wear out

Must touch target to sense

Relatively slow (five times/sec.) compared to electronic devices

Applications

Limit switches are used in a variety of applications. Consider these:

Limit switches can be used to turn off a washing machine if the load becomes unbalanced. In automobiles, they turn on lights when the door is opened.

In industry, limit switches are used to limit the travel of machine parts, sequence operations or to detect moving items on a conveyor system.

Limit Switch Components

A limit switch consists of three main components.

Limit Switch Components

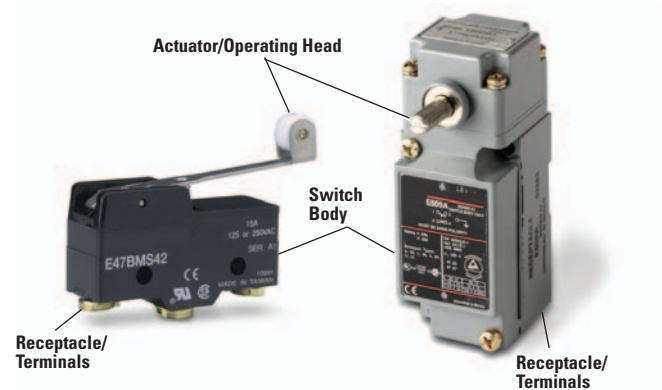

The **actuator** is the part of the limit switch that physically comes in contact with the target. In some limit switches, the actuator is attached to an **operating head**. The operating head translates a rotary, linear or perpendicular "triggering" motion into the motion type needed to open or close the electrical contacts of the switch.

The **switch body** is the component that contains the electrical contact mechanism.

The terminal screw or screw/clamp assembly necessary for wiring is referred to as the **receptacle**.

In the Workplace

At the Marathon T-Shirt Company, boxes of apparel approach the end of the packaging line, ready to be stacked onto pallets. A palletizer with suction-cup grippers picks up a box and swings it around to a waiting pallet.



A Limit Switch in Action

How does the unit know it has reached its sixth layer of boxes? When the pivot arm reaches the top of its vertical travel rod, the arm hits a limit switch. The switch signals the system to send the full pallet down line and sets up an empty pallet to restart the process.

Limit Switch Movement

Let's take a closer look at what actually happens as a limit switch is activated. Imagine a target object moving toward a limit switch actuator.

Limit Switch Movement

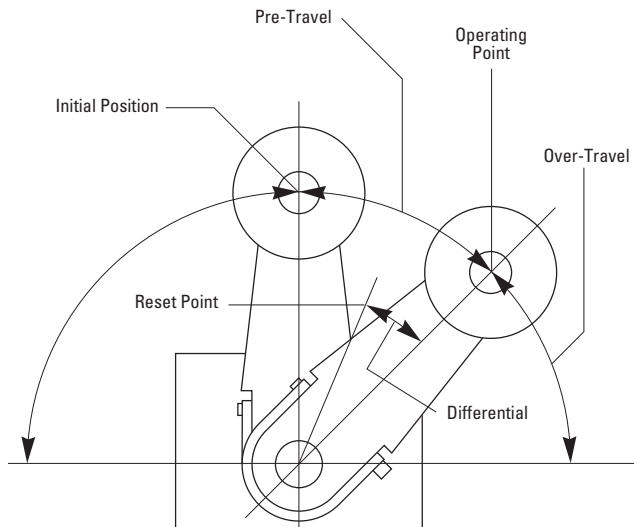

1. The actuator is at its **initial position**. The limit switch contacts are in their normal "untriggered" position.
2. Contact is made with the target object and the actuator moves its **pre-travel** distance. Contacts are still in their normal "untriggered" position.
3. The actuator reaches its **operating point** where the contacts change from their normal "untriggered" position to their "triggered" position.
4. The **differential** is the difference between the operating and release point. Differential is engineered into the switch to guard against the effects of vibration and rapid ON/OFF oscillations of the switch right at the operating point.

Notes

In the case of a lever actuator, there is some **over-travel** allowing the lever to move beyond the operating point.

On plunger actuators, the overtravel distance is a safety margin for the sensor to avoid breakage.

The actuator begins the return to its initial position. The contacts return to their normal "untriggered" position as the actuator reaches its **release point** and resets the contacts.

Limit Switch Movement Definitions

Here are a few other terms that are used in describing the movement of the limit switch actuator:

The **operating force** is the force required to move the actuating element.

The **minimum return force** is the minimum force required to return the actuator to its initial position.

The **total travel** is the maximum allowable distance the actuating element can travel.

The ability of a switch to repeat its characteristics precisely from one operation to the next is called the switch's **repeat accuracy**.

In the Workplace

Inside this sawmill, a high-speed saw quickly reduces logs to construction beams.



Limit Switches Working Where People Cannot

In the process, chips and dust hang in the air. Breathing is impossible in the area without a mask. Even with goggles, it would be impossible to inspect the cutting.

The production department devised a system of limit switches to do the inspecting automatically. A remote operator can configure a set of limit switches to allow the log to be cut to the desired dimensions.

Actuators and Operating Heads

Choosing the proper actuator (also called an **operating head**) for a limit switch depends on a number of application-specific factors. **To select an actuator, you need to know shape, speed, direction and total travel specifications.**

Operating heads fall into two broad types: **Maintained Contact** and **Momentary Contact**. Momentary contacts return to their normal state as soon as the actuator passes its release point. This type of operating head is also called “spring-return.”

With a maintained contact operating head, the contacts remain in the “triggered” position even after the actuator has been released. They are reset only by further mechanical action of the operating head. For example, on rotary operating heads, the contacts are reset by rotation in the opposite direction.

Actuators can take the form of rotary levers or plungers. We will look at specific actuator types on the next few pages.

Rotary Lever Actuators





A typical lever actuator functions something like this: **a cam or plate hits the end of the lever arm, which rotates a shaft and operates the contacts in the switch.**

The rotation may be momentary (spring-returned) or maintained. A lever arm can be a rod or a roller of a fixed or adjustable size. It may be made from any number of materials.



A rotary lever actuator is usually the best choice for the majority of applications. It can be used in any application where the cam moves perpendicular to the lever’s rotational shaft. This type of actuator also offers the benefit of a long life.

Let’s take a look at the different rotary lever actuator types available.

Rotary Lever Actuators and Limit Switches

	Lever Type	Application
	Standard roller	Used for most rotary lever applications. Available in various lengths. Roller typically made of Nylatron® for smooth operation and long wear.
	Ball bearing roller	Used where abrasive dust would cause undue wear of standard nylatron rollers. Also used with high-speed cams.
	Adjustable length	Used where the length of arm required is not known when devices are ordered or where the target size or location may change from day to day. An operator can adjust the arm length before beginning production.
	Forked	Used with maintained contact style switches. When rollers are on opposite sides, one cam will trip the switch and the second will reset the switch. When rollers are on the same side, one cam trips and resets the switch. Applied where the target approaches from two sides, such as a grinder that works back and forth.
	Offset	Used to obtain different cam track dimensions.

Rotary Lever Actuators, continued

Lever Type	Application
One-Way Roller 	One-way roller Used with reversible cams where operation in one direction only is required.
Rod or Loop 	Rod or loop Used where unusual shape is required. Rod is typically made of steel or nylon. The loop is made of Nylatron®.
Spring Rod 	Spring rod Used on conveyors where jam-ups may occur. Flexible rod moves in any direction and eliminates damage to arm or switch.

12





Plunger Actuators

A typical plunger actuator functions something like this: **a cam or plate hits the end of the plunger, which is pressed in and operates the contacts in the switch.**





A plunger actuator is the best choice to monitor short, controlled machine movements, or where space or mounting restrictions will not permit the use of a lever actuator.

Lets take a look at the different plunger actuator types available.

Plunger Actuators of Various Limit Switches

Lever Type	Application
Top Push Rod 	Top push rod Actuation must be done in line with plunger axis. Care should be taken to avoid exceeding the overtravel stated by the manufacturer. A mechanical stop should be used where the possibility of overtravel exists.
Side Push Rod 	Side push rod Should be used where the mounting permits operating from the side only and not the top. As with the top push rod, avoid exceeding recommended overtravel. Available in both momentary and maintained styles.
Top and Side Push Roller 	Top and side push roller The function is similar to push rod styles, except there is a roller attached to the end of the rod. Typically used where a lever arm will not fit for lateral actuation. Roller can be positioned either vertically or horizontally.
Pin 	Pin Most often used where extremely small differentials and operating forces are required.

Plunger Actuators, continued

	Lever Type	Application
Straight 	Straight	Used where the actuating element travels in same axis as plunger. Available in standard and extended lengths.
Lever 	Lever	Used in applications where the cam actuates in line with the plunger but may require a larger differential or where an appreciable side thrust is present.
Roller Level 	Roller level	Used in applications where the cam will pass by the switch laterally.
Roller Plunger 	Roller plunger	Used in applications where the cam may present some degree of side thrust. Roller helps deflect this.
Cat Whisker and Wobble Stick 	Cat whisker and wobble stick	Typically used in conveyor applications to count objects as they pass by. Can be actuated in any direction.

Mounting Considerations

When applying mechanical limit switches, consideration of the type of actuation needed, the mounting locale of the device and the speed of actuation are very important.

Cam Design

The cam angle should equal the lever arm angle for applications where the cam will not overtravel the actuator. Where relatively fast motions are involved, the cam should be of a shape that does not allow the actuator to receive a severe impact, or that releases the actuator suddenly allowing it to snap back freely.

Cam Design

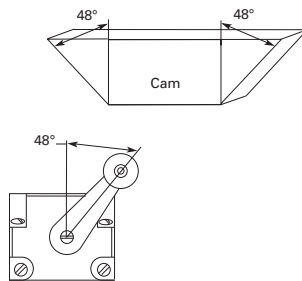

When using side-push or top-push plunger actuators, be sure the cam operates in line with the push rod axis. **Do not use the limit switch body to act as a mechanical stop for the cam in overtravel applications.** Some other type of barrier must be provided as the stop.

Mounting Location

Limit switches should never be mounted in locations that could allow false operations by normal movements of operator or machine components. They should be mounted rigidly, be maintenance accessible and have the cover plate facing that access point.

If liquid intrusion is a possibility, the switch should be mounted face down to allow gravity to prevent seepage through the seals on the operating head. All conduit connections should be tightly sealed.

In applications where machining chips or other debris accumulates, the limit switch should be mounted in a location, or at such an angle, that minimizes buildup on the operating head.

In the Workplace

At this leading frozen food processor, an automatic pallet stacking system is used. This system uses a wobble stick limit switch to detect when the pallets have been loaded to their desired level.

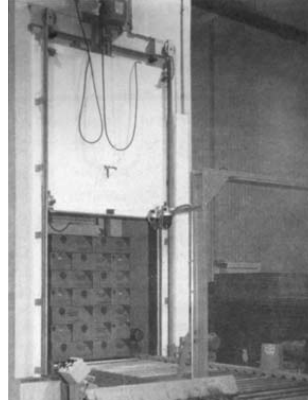

Into the Freezer

The switch then signals the conveyor to send the load through an automatic vertical rise door into the freezer for quick freezing.

Limit Switch Types

There are three basic classifications of limit switches available.

- Standard Industrial
- Hazardous Location
- Precision

Let's spend some time looking at each.

Standard Industrial Switch

Often the first choice for industrial applications, this switch functions in a variety of rugged industrial environments. **This type of switch can be subjected to oil, grease, dirt, high-pressure wash-down, shock, vibration, etc.**

Typically, these devices meet NEMA enclosure ratings of 1, 3, 3S, 4, 6, 12 and 13. An explanation of these ratings can be found in "Enclosure Ratings" on **Page V8-T12-39**.

Standard Industrial Switch



- ① Actuator/Operating Head
- ② Switch Body
- ③ Receptacle/Terminals

Most limit switches on the market today are a plug-in type design, which means that the operating head, switch body and receptacle are separate components. **If the switch becomes damaged or fails, it can be replaced in the field in less than a minute, without rewiring the switch.** Simply remove the switch body, and the wiring remains intact in the receptacle. The majority of new industrial applications use the plug-in type due to its flexibility and ruggedness.

Non plug-in types are a popular design for **DIN rail mounted limit switches**. These switches are built to meet dimensional and operational standards set in Europe. They have **typically the same electrical contact and enclosure ratings as the regular heavy-duty switches, but often their electrical and mechanical life is not as long**. They are an economical alternative for applications where the switch is not subjected to physical abuse.

Hazardous Location Switch

The hazardous location switch is ideal for use in harsh or dangerous environments. This switch is tough enough to contain an explosion within itself.

The one-piece switch body/receptacle is much heavier and thicker in construction than standard oil-tight switches. Like standard oil-tight switches, hazardous location switches have removable actuating heads attached to the switch body with four screws.

Hazardous Location Switch



This switch type generally meets NEMA 1 requirements, and the hazardous location requirements of NEMA 7, Class I, Groups B, C and D; and NEMA 9, Class II, Groups E, F and G. Some manufacturers offer models rated NEMA 4X and 13 as well (see “Enclosure Ratings” on **Page V8-T12-39** for more information).

Precision Limit Switch

The precision limit switch is widely used in both commercial and industrial applications, ranging from appliances to farm equipment. It is **often chosen for its precise operating characteristics, small size and low cost.**

Precision Limit Switches



Precision switches are typically available in two types: basic precision and enclosed precision. The basic precision switch is of one-piece construction. The enclosed precision switch is simply a basic switch inside a die cast housing. Basic precision switches are generally not given a NEMA enclosure rating, while some enclosed precision switches can be rated NEMA 4 or 13.

Special Purpose Limit Switch

Some applications require a limit switch to perform a special detection function. Let's take a look at some of the special purpose limit switches.

Special Purpose—Safety Guard



This type of switch is used to ensure safety for the operator of a dangerous machine. A standard limit switch could be false tripped or false actuated, posing a danger to the person operating the machine.

Actuation of this switch occurs only when a keyed interlock is inserted into the key slot. The key is usually mounted on a safety door or machine guard so that when it is closed, the key slides into the slot, actuating the switch.

Special Purpose—Gravity Return

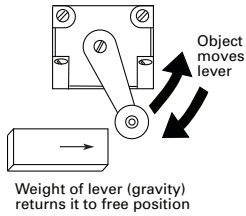

Unlike other rotary limit switches, this switch has no spring return mechanism. **The weight of the operating lever must provide the force to return it to its free position.** This switch is usually mounted with the operating head facing down.

It is often used in applications where very low operating forces from the target are required.

Special Purpose—Neutral Position

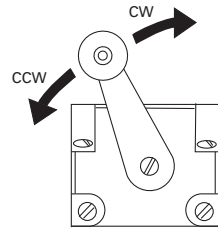

With this limit switch, the **direction of operation can be detected.**

One set of contacts is actuated when the lever is moved in one direction, and a second set of contacts is actuated when the lever is moved in the other direction.

Special Purpose—Two Step

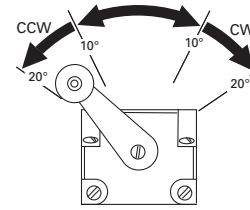

This switch **operates to perform two functions with one switch.** One set of contacts is activated after the lever is rotated 10°, and another set is activated at a 20° rotation (in the same direction).

This switch can monitor an object's height, orientation, position, completeness of assembly, etc.

In the Workplace

In some manufacturing plants, rooms need to be closed off quickly because of contamination or fire. To help facilitate this process, high-speed doors have been developed. These doors may move as quickly as six feet per second.

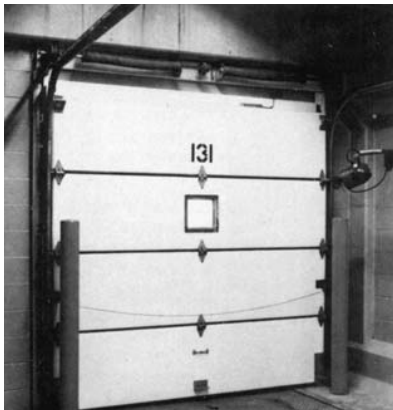

Limit Switches Help Operate This High-Speed Door

At such speeds, the door would destroy itself quickly, if not for the use of limit switches. The limit switches are used to slow the door just before it is fully opened or fully closed.

Review 2

Answer the following questions without referring to the material just presented. Begin the next section when you are confident that you understand what you've already read.

- The three main components of a limit switch are:

Match the terminology to the proper description:

- | | | |
|------------------------|-------|---|
| 2. Initial position | _____ | A. Distance the actuator can travel safely beyond the operating point |
| 3. Pre-travel distance | _____ | B. Maximum allowable distance the actuator can travel |
| 4. Operating point | _____ | C. Actuator and contacts are in the normal, or untriggered position |
| 5. Overtravel | _____ | D. Actuator's position at which the contacts change state |
| 6. Release point | _____ | E. Actuator position where the contacts are reset to their normal "untriggered" state |
| 7. Total travel | _____ | F. Actuator travel from contact with the target until the operating point |
8. The ability of a switch to repeat its characteristics from one operation to the next is called the switch's repeat accuracy. TRUE FALSE

Answers to Review 2 are on **Page V8-T12-41.**

Inductive Proximity Sensors

The inductive proximity sensor can be used to detect metal objects. It does this by creating an electromagnetic field.

With the ability to detect at close range, inductive proximity sensors are very useful for precision measurement and inspection applications.

Strengths and Weaknesses

Inductive Proximity Sensor Attributes

Attributes

Strengths

Immune to adverse environmental conditions

High switching rate for rapid response applications

Can detect metallic targets through non-metallic barriers

Long operational life with virtually unlimited operating cycles

Solid-state to provide a “bounce free” input signal to PLCs and other solid-state logic devices

Weaknesses

Limited sensing range (4 in or 100 mm maximum)

Detects only metal objects

May be affected by metal chips accumulating on sensor face

Applications

Proximity sensors are used in a variety of applications. Consider these:

Proximity sensors can be used to detect the end of travel on a positioning table, to determine speed by counting a gear’s teeth, or be used to check if a valve is fully opened or closed.

Proximity sensors can be used to detect the presence or absence of a metallic workpiece or metallic pallets on conveyor lines.

When a robot arm swings around for a pick and place operation, a proximity sensor makes sure the arm actually has a part in its grippers.

In metal machining, proximity sensors can make sure the workpiece is mounted in the fixture, and that the drill bit has not broken off.

How an Inductive Proximity Sensor Works

Inductive proximity sensors produce an oscillating and invisible radio frequency (RF) field at the sensor face. When metal objects are brought into this field, this oscillating field is affected. Each type and size of sensor has a specific sensing range switch point so that metal target detection is very accurate and repeatable.

The presence of a metallic target interrupts the field and alters (by **damping**) the current in the sensor coil (**eddy current kill**) causing the detector circuit to sense the change. The sensor then triggers an output to a connected device.

Components

Let’s look at the components and the process step-by-step:

Components

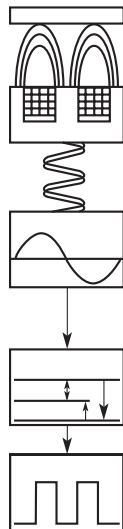

A metal object, or target, enters the sensing field.

The **sensor coil** is a coil of wire typically wound around a ferrite core. If you could see the electromagnetic field created by it, it would be cone shaped. The target will pass through this field.

The ferrite core shapes the field and the size of the coil determines the sensing range.

The **oscillator circuit** causes the field to cycle at a specific set radio frequency (100 KHz to 1 MHz). The presence of metal causes a change in the oscillation, and an eddy current forms on the target. The metallic object **induces** a change in the magnetic field. This change creates a damping effect on the amount of signal that cycles back to the sensor coil.

The **detector circuit** senses the change and switches ON at a particular set point (amplitude). This ON signal generates a signal to the solid-state output.

The **output circuit** remains active until the target leaves the sensing field. The oscillator responds with an increase in amplitude, and when it reaches the set point, the detector circuit switches OFF. The output returns to its normal state.

Hysteresis

Hysteresis is an engineered-in difference between the ON and OFF points.

If they were exactly the same point, there would be a chattering—a very rapid on-off-on-off cycle. That would cause a lot of needless stress on components activated by the circuit.

Hysteresis

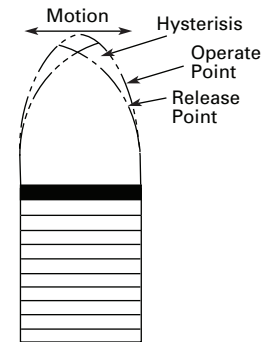







With hysteresis, the **operate point** and the **release point** are slightly different distances from the sensor face.

Proximity Sensor Types

Proximity sensors come in a wide variety of designs to meet the requirements of almost any industrial application. Let's take a brief look at the types that are available.

Proximity Sensors

	Type	Application
Modular Limit Switch Type 	Modular limit switch type	The modular design can be tailored for many application types. Components can be easily switched out for short-run manufacturing changes.
Unitized Limit Switch Type 	Unitized limit switch type	The sealed body protects the components in corrosive environments.
Tubular 	Tubular	This is the design of choice for a growing number of applications. The small size allows for easy mounting in a fixture or for use in tight spaces found on many assembly lines.
Right Angle Tubular 	Right angle tubular	This style enables mounting in tight locations.
High Current Tubular 	High current tubular	Enables the smaller tubular design to carry extremely large inrush and continuous currents. Excellent for heavy equipment such as lift trucks.
Composite Housing 	Composite housing	This corrosion-resistant unit performs well in high wash-down areas such as food processing, or places where caustic chemicals abound.
Pancake 	Pancake	The extra wide coil on this unit achieves the widest and farthest range available: 3.94 in. Ideal for oil rig applications and assembly of large parts.

In the Workplace

Without proximity sensors, the tips of the digits on the grippers of a robotic arm would be numb.



Proximity Sensors Allow a Robotic Arm to Safely Handle Fragile Components

Coupled with the robot's software control program and the responsive sensing ability of proximity sensors, a robot can grasp an object and not crush it.

Review 3

Answer the following questions without referring to the material just presented. Begin the next section when you are confident that you understand what you've already read.

1. Match the sensor component name to the correct picture.

1 a. Oscillator _____
 b. Output _____
 c. Detector _____
 d. Sensor coil _____

Match the proximity sensor component with its function.

- 2. Sensor coil _____ A. Sets up an electromagnetic field to create a wave pattern
 - 3. Oscillator _____ B. Alerts the electrical circuit that an object has been detected
 - 4. Detector _____ C. Shapes the electromagnetic field
 - 5. Output _____ D. Looks for a change in frequency
6. Hysteresis is the gap between the operate point and the release point to smooth the operation of the sensor. TRUE FALSE

Answers to Review 3 are on **Page V8-T12-41**.

Inductive Proximity Sensor Influences

When applying inductive proximity sensors, it is important to understand the sensing range and the factors that influence that range. **The sensing range refers to the distance between the sensor face and the target.** It also includes the shape of the sensing field generated through the coil/core.

There are four main concerns when selecting and applying proximity sensors:

- Target considerations (material, size, shape and approach)
- Coil size and shielding
- Sensor mounting requirements
- Environment

Target Material

You need to know the target's material. This information will help you determine the maximum sensing distance. Exceed this distance, and the damping effect necessary to trip the sensor's output will not be created—and the sensor will fail to sense the target.

Proximity sensors work best with ferrous metals.

Though these sensors detect other metals, the range will not be as great. Generally, the less iron in the target, the closer the target has to be to the sensor to be detected.

Manufacturers generally provide charts showing the necessary correction factors for various types of metals when applying their sensors. Each sensor style will have a correction factor to enable calculation for a particular target material.

Target Size

The size of the target also matters. If you run a target smaller than the sensor's "standard size," sensing range will decrease. This is because a smaller target creates a weaker eddy current. However, a bigger target does not mean a longer sensing range.

The thickness of the target does not impact sensing range much. However, a very thin non-ferrous target can actually achieve a greater sensing range because it generates an eddy current on both sides (known as the foil effect).

So, how big should the target be? **The rule of thumb is: the size of the sensor's diameter, or three times the sensor's sensing range, whichever is greater.**

Target Shape

The shape of the target can have an impact on the sensing range. A round object, or an object with a rough surface can affect the damping effect of the sensor, and may require a closer sensing distance. Using a larger sensor size or an extended range sensor will also minimize this effect.

Target Approach

How the target approaches the sensor matters as well.

When an object comes at the sensor straight on, that's an **axial approach**. With this type of approach, you will need to protect the sensor physically. Allow for 25% overtravel.

Axial Approach

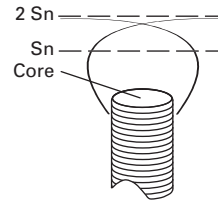

Hysteresis tends to be greater for an axial approach than a lateral approach.

Lateral Approach

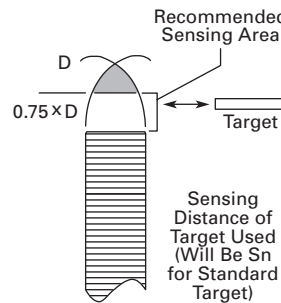

On a slide-by, or **lateral approach**, the target approaches the center axis of the sensing field from the side.

The target should not pass closer than the basic tolerance built into the machine design. Targets bumping into your sensor are a sure guarantee of eventual poor sensor performance.

For both approach types, make sure the target passes not more than 75% of the sensing distance from the sensor face. It is in this "tip" area that variations in the sensing range occur.

Coil/Core Size

An important factor in the range of the sensor is the construction of the coil/core. An open coil with no core will produce a field that could be actuated by a target from any direction. That wouldn't be very practical for industrial applications.

For an inductive proximity sensor, the sensor **coil** that generates the field fits inside of a ferrite core. This cup-shaped piece of ferrite material is called a **cup core**. This core directs the field and shapes it.

Coil/Core Construction

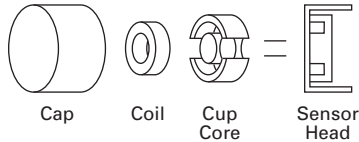

A protective **cap** prevents dust or other environmental hazards from entering the sensor.

Mounting Considerations

A shielded sensor can be fully **embedded** in a metal mounting block without affecting the range. It is sometimes referred to as a flush mount sensor.

A non-shielded sensor needs clearance around it (called the metal-free zone) which is determined by its sensing range. Otherwise, the sensor will sense the metal mounting and be continuously operating.

Mounting two sensors closely together can also be a problem. If you position two proximity sensors too close together—either side by side or facing each other head to head—the two fields will clash with one another. **Each sensor needs to be mounted at least three times its own sensing range away from the other.** The use of an alternative frequency head on one of the sensors will prevent adjacent sensors' sensing fields from interacting.

The design of a sensor can affect how it is mounted.

Clear Zone

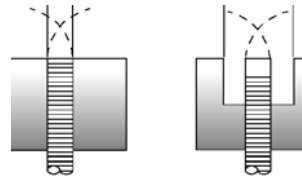

Shielding

To focus the intensity of the field, the coil can be **shielded**. In a standard range sensor, the ferrite cup core shapes the field to emanate straight from the sensing face of the sensor. In a sense, shielding it.

An extended range coil/core assembly does not use the standard cup core, just a core of ferrite. This **unshielded** device allows the extension of the sensing range. There is less ferrite to absorb the electromagnetic field, so its range is wider and a little longer.

The decision to use a non-shielded sensor will impact the mounting of the sensor, as we will discuss that next.

Shielding

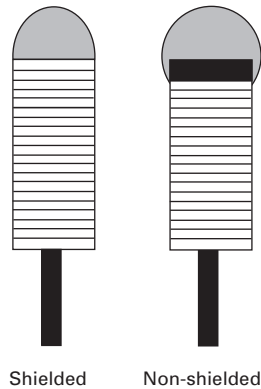

In the Workplace

At an auto manufacturing plant, a drilling operation is performed on the valve blocks to allow for mounting the cover plates. The operation is totally unmanned.

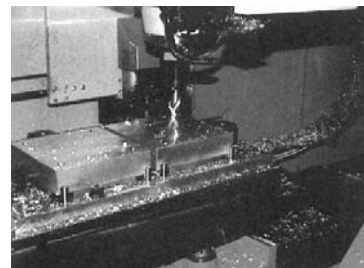

An Inductive Proximity Sensor Monitors Drilling Operation

The drill bit must form holes in an extremely hard material. Breaking drill bits is a fairly common occurrence. For this reason, a proximity sensor is in place. If a break occurs, the sensor signals the system to stop the operation so the drill bit may be replaced.

Environment

The sensor's environment can affect its performance dramatically. Let's take a look at some of these environmental factors.

Debris can accumulate on the sensing cap, changing the range of the sensing field. In an application where metal chips are created, the sensor should be mounted to prevent those chips from building up on the sensor face. If this is not possible, then coolant fluid should be used to wash the chips off the face. An individual chip generally doesn't have enough surface area to cause the sensor to turn on, but several of them could extend the sensing range and interfere with the accuracy of the sensor.

Magnetic fields caused by electrical wiring located in the vicinity may affect sensor operation. If the field around the wires reaches an intensity that would saturate the ferrite or the coil, the sensor will not operate. Sensors used in areas with high frequency welders can also be affected. To compensate for a welder, weld field immune sensors can be installed. Or, if the sensor is used with a PLC, a time delay can be programmed to ignore the signal from the sensor for the time period that the welder is operating.

Radio transceivers (such as a walkie-talkie) can produce a signal with the same frequency as the oscillator circuit of the sensor. This is called radio frequency interference (RFI). Most manufacturers have taken steps to provide the maximum protection against RFI and false operation of the sensor.

Electrical interference from nearby motors, solenoids, relays and the like could have an affect on sensor operation as well. **An induced line or current spike** (called a showering arc or EFT) **can cause a false operation of the sensor.** This spike can be produced by the electrical arc created when an electrical/mechanical switch or a contactor closes. If the lines connecting the sensor and these devices are adjacent and parallel to one another, the spike will affect the sensor. Most codes and specifications call for a separation of control and power leads so this is not often a problem.

The ambient temperature can affect sensing range. The effect is referred to as temperature drift. The sensing range can change by as much as $\pm 10\%$.

Because sensing ranges can vary due to component, circuit and temperature variations, along with the effects of normal machine wear, **sensors should be selected based on sensing the target at 75%, and releasing at 125% of the rated sensing distance.**

Sensing Distance Tolerances

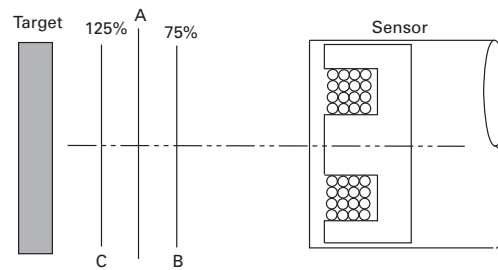

A = Rated Sensing Range
B = Maximum Usable Sensing Range
C = Maximum Reset / Release Range

In the Workplace

On the automated processing line at Harris House Paints, a can would occasionally come through the packaging process without a lid. Lids entered the line through a gravity feed and occasionally a lid would get momentarily hung up.



An Inductive Proximity Sensor Keeps a Lid on Things

By mounting an inductive proximity sensor over the passing cans, the line could reject a can with a missing lid.

Review 4

Answer the following questions without referring to the material just presented. Begin the next section when you are confident that you understand what you've already read.

- Inductive proximity sensors work best with _____ metals.
- The target size rule of thumb is: the size of the sensor's diameter, or three times the sensor's sensing range, whichever is greater. TRUE FALSE
- A target with a rough surface has no impact on the sensing range. TRUE FALSE
- A slide-by approach to the sensor is called a lateral approach. TRUE FALSE
- A straight on approach is called an axial approach. TRUE FALSE
- When two sensors are to be mounted side-by-side, the use of an alternate frequency head on one of the sensors will not prevent the sensors' sensing fields from interacting. TRUE FALSE

Answers to Review 4 are on **Page V8-T12-41**.

Capacitive Proximity Sensors

Let us now turn our attention to another proximity sensor, the capacitive proximity sensor. This sensor operates much like an inductive proximity sensor, but its means of sensing is much different.

Capacitive Proximity Sensors



Capacitive proximity sensors are designed to detect both metallic and nonmetallic targets. They are ideally suited for liquid level control and for sensing powdered or granulated material.

Strengths and Weaknesses

Consider these strengths and weaknesses of the capacitive proximity sensor:

Capacitive Proximity Sensor Attributes

Attributes

Strengths

Can detect both metallic and nonmetallic objects at greater ranges than inductive sensors

High switching rate for rapid response applications (counting)

Can detect liquid targets through non-metallic barriers (glass, plastic)

Long operation life, solid-state output for "bounce free" signals

Weaknesses

Affected by varying temperature, humidity and moisture conditions

Not as accurate as inductive proximity sensors

Applications

Here are some examples showing how the detection power of capacitive proximity sensors is used:

- **Liquid level detection applications**, such as preventing overflowing or underfilling, are common in the packaging industry.
- **Material level control applications**, such as assuring that a sleeve of labels on a labeling line is not empty.
- **Counting applications**, such as tracking units passing a point on a conveyor.
- **Induction molding process**, detection of level of plastic pellets in feed hopper.

Operation of the Capacitive Proximity Sensor

A capacitor consists of two metal plates separated by an insulator (called a **dielectric**).

The operation of this type of sensor is based on dielectric capacitance, which is the ability of a dielectric to store an electrical charge.

The distance between the plates determines the ability of the capacitor to store a charge.

Measuring the change in capacitance as an object enters the electrical field can be used as an ON/OFF switching function.

Capacitor Operation

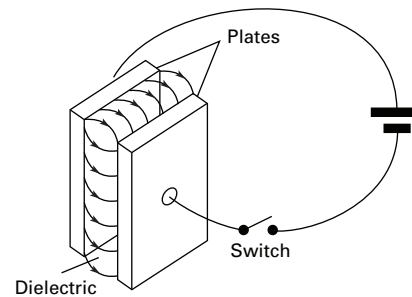

When this principle is applied to the capacitive proximity sensor, **one capacitive plate is part of the switch, the enclosure (the sensor face) is the insulator. The target is the other "plate."** Ground is the common path.

Capacitive proximity sensors can detect any target that has a dielectric constant greater than air. Liquids have high dielectric constants. Metal also makes a good target.

Capacitive Proximity Sensor Operation

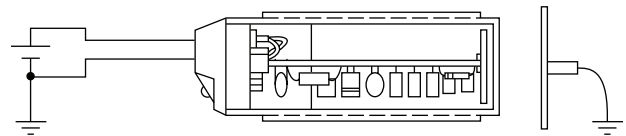

The capacitive proximity sensor has four basic elements: a sensor (which is a dielectric), an oscillator circuit, a detector circuit and an output circuit.

As an object approaches the sensor, the **dielectric constant of the capacitor changes**. The oscillator circuit's **oscillation begins when feedback capacitance is detected**. This is just the opposite in the inductive proximity sensor, where the oscillation is damped when the target is present.

Oscillator Damping

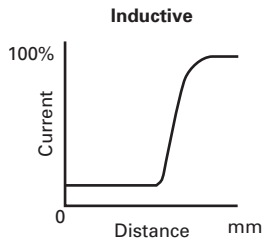

The **detector circuit** monitors the oscillator's output. When it detects sufficient change in the field, it switches on the output circuit.

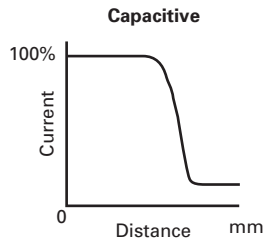

The **output circuit** remains active until the target leaves the sensing field. The oscillator responds with a decrease in amplitude, and when it is no longer receiving sufficient capacitance feedback, the detector circuit switches OFF.

There is a built-in **difference between the operate and release amplitudes to provide hysteresis.**

In the Workplace

As oil pours into this storage tank, a capacitive proximity sensor near the top signals the fill valve to close once the tank reaches capacity.



Capacitive Proximity Sensors in a Liquid Level Detection Application

Another sensor near the bottom alerts the filling system if the level of the tank becomes too low.

Capacitive Proximity Sensor Influences

Many of the same factors that influence the sensing range of inductive proximity sensors, also influence the sensing range of capacitive proximity sensors.

Typically, capacitive sensors have a greater sensing range than inductive sensors.

Sensing distance for capacitive proximity sensors is dependent on plate diameter. With inductive proximity sensors, the size of the coil is the determining factor.

Sensitivity Adjustment

Most capacitive proximity sensors are equipped with sensitivity adjustment potentiometers. Because the sensor measures a dielectric gap, it is important to be able to compensate for target and application conditions and adjust the sensing range.

Target Material and Size

A capacitive sensor should not be hand-held during set up. Because your hand has a dielectric constant greater than air, the sensor may detect your hand rather than the intended target.

Capacitive sensors can detect both ferrous and non-ferrous materials equally well. **There is no derating factor to be applied when sensing metal targets.** But, other materials do affect the sensing range.

Because they can be used to detect liquid through a nonmetallic material such as glass or plastic, you need to ensure that the sensor detects just the liquid, not the container. **The transparency of the container has no effect on the sensing.**

For all practical purposes, the target size can be determined in the same manner as was discussed in "Target Size" on **Page V8-T12-18** for inductive proximity sensors.

Typical Proximity Sensing Ranges

Sensor with a Tubular Diameter of:	Inductive Unshielded Sensor	Capacitive Unshielded Sensor
18 mm	8 mm	15 mm
30 mm	15 mm	25 mm
34 mm	—	35 mm

Environment

Many of the same factors that affect inductive proximity sensors, also affect capacitive sensors, only more so.

- Embeddable mounting—capacitive sensors are generally treated as **non-shielded devices**, and therefore, **are not embeddable**.
- Flying chips—they are **more sensitive to both metallic and nonmetallic chips** and residue.
- Adjacent sensors—**more space between devices is required** due to the greater, non-shielded sensing range.
- Target background—because of both the greater sensing range, and its ability to sense metallic and nonmetallic materials, **greater care in applying these sensors is needed when background conditions are present**.
- Ambient atmosphere—the **amount of humidity in the air may cause a capacitive sensor to operate** even when no target is present.
- Welding magnetic fields—capacitive sensors **are generally not applied in a welding environment**.
- Radio Frequency Interference (RFI)—in the same way that inductive proximity sensors are affected, **RFI interferes with capacitive sensor circuitry**.
- Showering arc (EFT)—**induced electrical noise affects these sensors** in the same way it does for an inductive sensor.

In the Workplace

On the fill line at Bud Springs Natural Water, two liter plastic bottles pass along beneath a fill nozzle.



A Capacitive Proximity Sensor “Sees Through” a Wall to Find the Target

As water fills each bottle, a capacitive proximity sensor detects when the water reaches the specified level. As the sensor is more sensitive to water than it is to plastic, the sensor can “see through” the bottle wall.

Review 5

Answer the following questions without referring to the material just presented. Begin the next section when you are confident that you understand what you’ve already read.

1. The operation of a capacitive proximity sensor is based on dielectric capacitance. TRUE FALSE
2. The four main parts of a capacitive proximity sensor are:

3. By measuring the change in capacitance as an object enters the field generated by the oscillator, it can be used for an on/off switching function. TRUE FALSE
4. When feedback capacitance is detected, the oscillation ends. TRUE FALSE
5. When sensing metal targets, a derating factor must be applied. TRUE FALSE
6. The transparency of the container has no effect on the sensing. TRUE FALSE

Answers to Review 5 are on **Page V8-T12-41**.

Photoelectric Sensors

The photoelectric sensor is a device with tremendous versatility and relatively low cost. Photoelectric sensors can detect objects more quickly and at further distances than many competitive technologies. For these reasons, photoelectric sensors are quickly becoming one of the most popular forms of automatic sensing used in manufacturing.

Photoelectric Sensors



12

Applications

Photoelectric sensors can provide solutions to a number of sensing situations. Some of the common uses for photoelectric sensors include:

Material Handling. A sensor can ensure that products move along a conveyor line in an orderly manner. The sensor will stop the operation if a jam occurs. And items can be counted as they move down the line.

Packaging. Sensors can verify that containers are filled properly, labeled properly and have tamper-proof seals in place.

Machine Operation.

Sensors can watch to verify that a machine is operating properly, materials are present and tooling is not broken.

Paper Industry. Sensors can detect web flaws, web splice, clear web and paper presence, while maintaining high web speeds.

Design Flexibility

Photoelectric sensors offer design flexibility to handle many types of situations. There are a variety of ways the transmitter and receiver can be arranged to meet the needs of the application.

Modes of Operation

We will briefly introduce you to these modes, and fully explain them later.

Photoelectric Sensor Operation Modes

Mode	Description
Thru-Beam 	Thru-beam A source unit in one location sends a light beam to a detector unit in another location. An object is detected when it passes between the source unit and the detector unit, interrupting the light beam.
Reflex 	Reflex (retro-reflective) The source and detector are housed in one package and placed on the same side of the target object's path. When the object passes by, the source signal is reflected back to the detector by a retroreflector.
Diffuse Reflective 	Diffuse reflective The source and detector are housed in one package and placed on the same side of the target object's path. When the object passes by, the source signal is reflected back to the detector off the target object itself.
Background Rejection (Perfect Prox) 	Background rejection This is a special type of diffuse reflective sensor that includes two detectors. This arrangement allows the sensor to detect targets reliably within a defined range, and to ignore objects just outside of this range. Unlike a standard diffuse reflective sensor, color or reflectivity has minimal effect on the sensing range of a Perfect Prox sensor.

In the Workplace

At the tollbooth, the gate raises only when you have tossed in your coins. But how does the gate know when to drop back into place?



A Photoelectric Sensor Prevents Commuters from Following You Through the Toll Booth for Free

The gate is controlled by a photoelectric sensor that detects your car as it passes through the beam.

Basic Operation of Photoelectric Sensors

The operation of the photoelectric sensor is quite simple. **A source LED sends a beam of light, which is picked up by a photodetector.**

When an object moves into the path of the light beam, the object is detected.

Let's look at how a photoelectric sensor works.

Photoelectric Sensor Operation

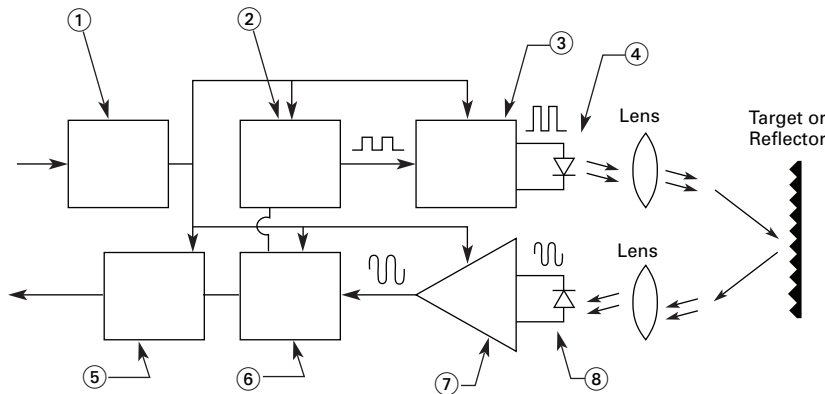

Notes

- ① **Power Supply:** Provides regulated DC voltage and current to the sensor circuitry.
- ② **Modulator:** Generates pulses to cycle amplifier and LED at desired frequency.
- ③ **Source Current Amplifier**
- ④ **Source LED**
- ⑤ **Output:** Performs switching routine when directed to do so by the demodulator.
- ⑥ **Demodulator:** Sorts out the light thrown out by the sensor from all other light in the area. If the demodulator decides the signals it receives are okay, it signals the output.
- ⑦ **Detector Amplifier:** Blocks current generated by the background light. It also provides amplification of the detected signal to a usable level, and sends it through to the demodulator.
- ⑧ **Photodetector:** Either a photodiode or a phototransistor device, selected for a maximum sensitivity at the source LED's emitted light wave-length. Both the source LED and the detector have protective lenses. When the detector picks up the light, it sends a small amount of current to the detector amplifier.

The Light Source







The light generated today by a photoelectric sensor comes from **light emitting diodes**, called LED. Using LEDs offers many significant advantages:

- Can be rapidly switched and instantly turned ON and OFF
- Extremely small
- Consume very little power
- Generate a negligible amount of heat
- Life exceeds 100,000 hours (11 years) continuous use
- Easily modulated to block false sensor triggering from ambient light

Photoelectric Sensor Styles and Uses

General Purpose

General Purpose Photoelectric Sensors

	Style	Application
Limit Switch Type 	Limit switch type	A modular head, sensor body and receptacle enable use in a variety of situations. Wide detection range. Popular replacement for standard limit switch applications.
Tubular 	Tubular	Small, easy to mount body enables mounting within machinery and other tight places. This sensor comes end sensing and right angle view packages, depending upon the type of mounting required.
Harsh Duty 	Harsh duty	Heavy-duty construction makes this sensor ideal for rugged environments.
Compact 	Compact	A family of high performance AC/DC and DC photoelectric sensors in a familiar package.
Fiber Optics 	Fiber optics	Made for fast response and for sensing in very tight areas. The cables are made of individual glass or plastic fibers and contain no electronics.
Terminal Base 	Terminal base	Self-contained in an impact-resistant, resin-molded case, these devices have pre-wired cables or terminal connections.
Miniature 	Miniature	A complete line of miniature photoelectric sensors for optimum placement and protection with no compromise in performance.

Fiber Optics

Applying **fiber optic** technology to photoelectric sensors means applications with space restrictions are not a problem. A fiber optic cable can detect objects in locations too jammed for a standard sensor. **Fiber optic cable is available in sizes as small as 0.002 inches in diameter.**

Glass Fiber Optic Cable

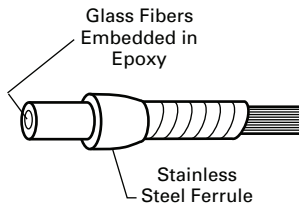

A glass fiber optic cable is made up of a large number of individual glass fibers, sheathed for protection against damage and excess flexing. Plastic fiber optic cables include a single plastic fiber in a protective coating. Neither type of cable contains electronics.

Because light—rather than

current—travels down these cables, **the signal is unaffected by electromagnetic interference (EMI) and vibration.** The design also has built-in immunity to electrical noise and the inaccurate readings regular sensors can get.

Fiber optics can withstand high temperatures; plastic up to 158°F (70°C), standard glass up to 480°F (249°C), and specialized high temperature versions up to 900°F (482°C). Glass fibers can stand up to the harsh wash-down chemicals used in many food, beverage and pharmaceutical applications.

However, fiber optics have their disadvantages. They have a limited sensing distance, so they can be used only in tight areas. The maximum distance for the thru-beam design is just 15 inches. Also, these sensors have a small sensing area. A small drop of water or piece of dirt can easily fool fiber optics.

In the Workplace

In this cookie kitchen, fiber optic photoelectric sensors are placed in a hot oven. As long as the sensors detect motion as the trays of cookies move by, the oven stays on.



A Photoelectric Sensor Prevents Cookies from Being Burned

If the conveyor stops, the sensors will detect light or dark for too long, and the output device will shut the oven down.

Modes of Detection

In most applications, photoelectric sensors **generate an output** any time an object is detected.

Light Operate vs. Dark Operate

If this occurs **when the photodetector sees light**, the sensor is said to be working in the **light operate** mode.

Light Operate and Dark Operate—Reflex Mode Example

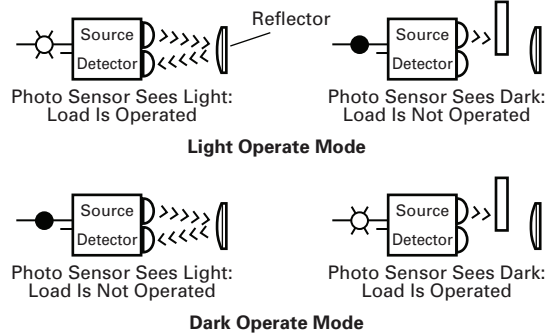

If the control **generates an output when the photodetector does not see light**, the control is said to be working in the **dark operate** mode.

Earlier, we briefly described the four basic operating modes that photoelectric sensors offer. These are:

- Thru-beam
- Reflex (retro-reflective)
- Diffuse reflective
- Background rejection (Perfect Prox)

Let's now take some time to understand how each method works.

Thru-Beam

Separate light source and detector units face one another across an area. The column of light traveling in a straight line between the two lenses is the effective sensing beam. An object crossing the path has to completely block the beam to be detected.

Thru-Beam Operation

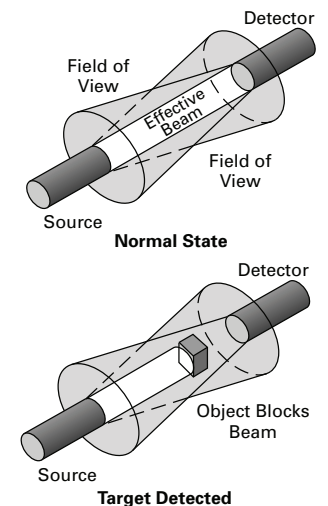

Thru-Beam Attributes

Attributes
Strengths
Long sensing distance (up to 800 ft)
Highly reliable
Can see through opaque objects
Weaknesses
Two components to mount and wire
Alignment could be difficult with a longer distance detection zone

Reflex or Retro-Reflective

The source and detector are positioned parallel to each other on the same side of the object to be detected. Another element, called a retroreflector, is placed across from the source and detector. The retroreflector is similar to a reflector on the back of a bicycle. The retroreflector bounces the light from the source back to the detector.

When a target object passes between the source/detector unit and the retroreflector, the beam is no longer reflected, and the target is sensed. The target has to block the entire beam.

In some cases, a reflex sensor can be falsely triggered by reflections from a shiny target's surface. To avoid this, a **polarized reflex sensor** can be used. The polarizing filter on the sensor ensures that only the light reflected by a retroreflector is recognized by the sensor.

Reflex Attributes

Attributes

Strengths

- Medium range sensing distance
- Low cost
- Ease of installation
- Alignment does not need to be exact
- Polarizing filter allows detecting shiny surfaced objects without false tripping

Weaknesses

- Reflector must be mounted
- Problems detecting clear objects
- Dirt on retroreflector can hamper operation
- Not suitable for detecting small objects

Reflex Operation

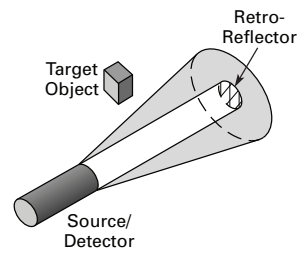

Normal State

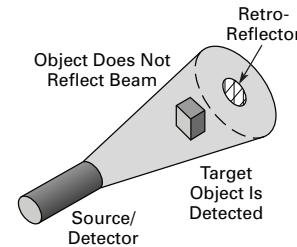

Target Detected

Diffuse Reflection

The source and detector are positioned on the same side of the target. The two components are aligned so that their fields of view cross.

When the target moves into the area, light from the source is reflected off the target surface back to the detector.

Diffuse Reflection Operation

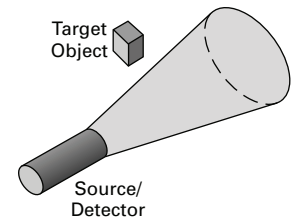

Normal State

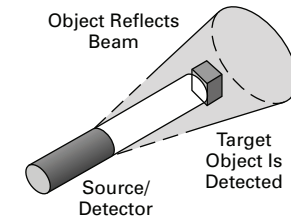

Target Detected

Diffuse Reflective Attributes

Attributes

Strengths

- Application flexibility
- Low cost
- Easy installation
- Easy alignment
- Many varieties available for many application types

Weaknesses

- Short sensing distance (under 10 ft)
- Sensing distance depends on target size, surface and shape

Background Rejection (Perfect Prox)

This detection scheme is really a **special type of diffuse reflective sensor**. It combines **extremely high sensing power with a sharp optical cut-off**. This allows the sensor to reliably detect targets regardless of color, reflectance, contrast or surface shape, while ignoring objects just outside of the target range.

This method **uses two different photo-detectors**. For the Perfect Prox unit with a six-inch range, the near detector has a range of 0 to

24 inches. Its far detector has a range of 6 to 24 inches.

Objects closer than six inches are detected only by the near detector. Objects between 6 and 24 inches are detected by both detectors.

If the near signal is stronger than the far signal, the sensor output is ON. If the far signal is stronger or equal to the near signal, the output is OFF. The result is a sensor with high **excess gain** for six inches, followed by a sharp cut-off.

Perfect Prox Sensor

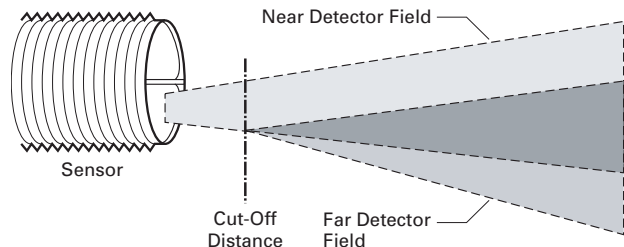

In the Workplace

Hobbes Gear wanted to reduce the number of gears rejected on their line. One critical process is the automatic drilling of the gear’s mounting hole. To increase the reliability of the inspection process, Hobbes installed a Perfect Prox sensor.

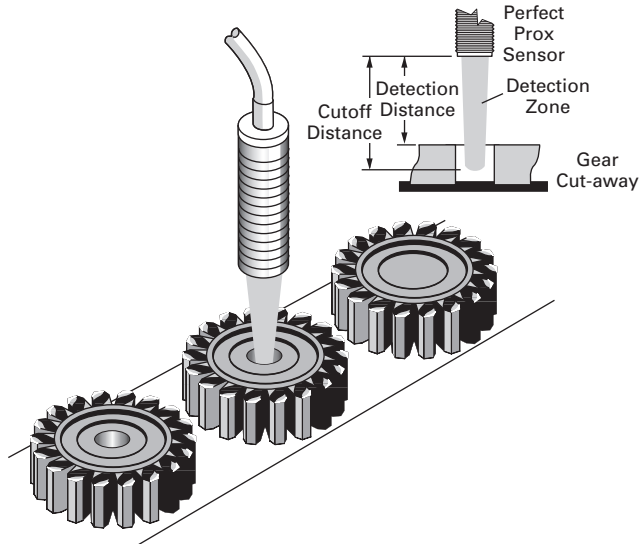

A Perfect Prox is “Inspector #12”

The sensor is set to check for the presence of the machined hole in the gear. If the hole is present, the sensor’s light shines through it, to the conveyor belt. The belt is just beyond the sensor’s sensing distance. If a missing hole is detected, the sensor signals an air-operated cylinder plunger to reject the gear.

Review 6

Answer the following questions without referring to the material just presented. Begin the next section when you are confident that you understand what you’ve already read.

1. The four modes of detection are:

2. If the photoelectric sensor control generates an output when the photodetector does not see light, the control is working in the dark operate mode. TRUE FALSE

Match the mode of detection with its definition.

- | | | |
|---|-------|-----------------------|
| 3. Mode of detection that senses by reflecting light off the objects | _____ | A. Reflex |
| 4. Sensing mode that has the longest range | _____ | B. Perfect Prox |
| 5. Sensing mode that combines extremely high sensing power with a sharp optical cut-off | _____ | C. Thru-beam |
| 6. A polarizing filter used with this sensing mode ensures that only the light reflected by a retro-reflector is recognized by the sensor | _____ | D. Diffuse reflective |

Answers to Review 6 are on **Page V8-T12-41**.

Excess Gain

Definition

Excess gain is a measurement of how much sensing power a photoelectric sensor has available beyond the power required to detect an object.

An excess gain of 1.00 at a given range means there is exactly enough power to detect an object **under perfect conditions at that range**. In other words, **the range at which the excess gain equals 1.00 is the maximum range of the sensor**.

Every model of sensor comes with an excess gain chart to help you determine the excess gain for an application's sensing distance.

However, we have to take into consideration the following real-world variables:

- Target size
- Target color
- Target surface texture
- Ability to block the beam
- Background
- Application environment

In the real world, there is contamination—dust, humidity and debris—that can settle on the lenses and reduce light transmission. Furthermore, each individual target may vary slightly from the next in color, reflectivity or distance from the sensor.

If you use a sensor with an excess gain of exactly 1.00, you stand an excellent chance of not sensing the target reliably. To cover yourself, **you need a sensor with the highest excess gain possible at the intended range**. This ensures the sensor will continue to operate reliably when you need it. As the level of contamination gets worse, more excess gain will be needed to get past the poor visibility.

Thru-Beam

This type of sensor's excess gain is the simplest to measure. **Excess gain is almost exclusively a function of the separation between the source unit and the detector unit.**

When implementing the excess gain for an application, start with the excess gain chart for the thru-beam sensor. Then consider:

- Misalignment of the two units
- Dirt in the environment reduces gain

Typical Gain Curve for a Thru-Beam

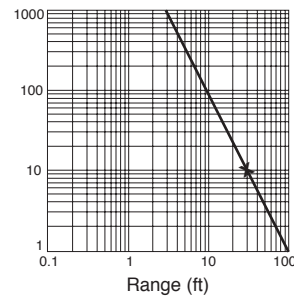

How to read the gain graph. If these sensors are spaced 30 ft apart, the excess gain at that distance would be an excess gain of "10".

Diffuse Reflection

Nearly every diffuse reflective sensor has a unique combination of lenses and beam angles.

As a result, nearly every sensor has a unique excess gain curve.

Diffuse Reflection Ranges

Long Range Perfect Prox Example

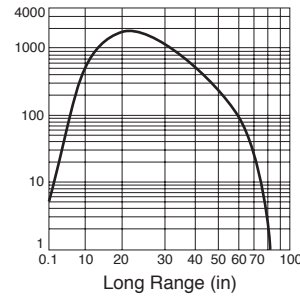

Short Range

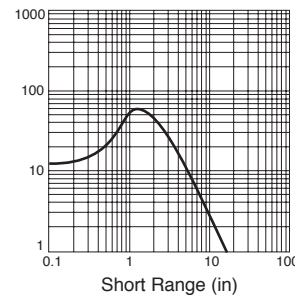

Focused Diffused Reflective

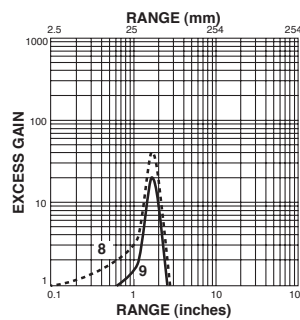

- 8. 13102A Typical
- 9. 13102A Minimum

Sensing range of diffuse mode sensors referenced to 90% reflective white target.

A short-range sensor delivers high excess gain over a short sensing distance and drops off quickly.

The source's beam and the detector's field of view converge a short distance from the lenses. The energy present in that area is very high, allowing the detection of small targets. The sensor also ignores objects in the near background.

Short-Range and Long-Range

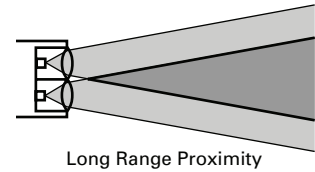
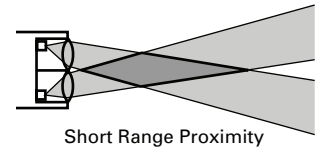

A long-range sensor's source beam and detector's field of view are positioned close together on the same axis. The ability to sense extends quite a distance. **Excess gain peaks out several inches from the sensor, then drops off slowly over distance.**

To sense into holes or cavities, or to pick up very small objects, use a focused diffuse reflective sensor. Or, a sensor with a very small light spot size. The source and detector are positioned behind the lens in order to focus the energy to a point. The excess gain is extremely high at this point and then drops off on either side of the sensing zone.

Reflex

Calculating the excess gain for a reflex (retro-reflective) sensor is similar to the method used for diffuse reflective sensors.

With this type of sensor, **excess gain and range are related to the light bouncing back from the reflector.** Maximum

operating range also depends upon lens geometry and detector amplifier gain.

The effective beam is defined as the actual size of the reflector surface. The target must be larger than the reflector before the sensor will recognize the target and switch its output.

Effective Reflex Sensor Beam

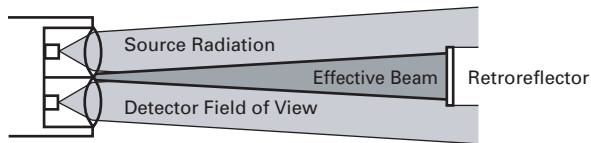

Light Curtain

A light curtain is a specialized reflex sensor head. It has four transmitters and four detectors side by side behind a cylindrical lens. The light curtain emits a fan-shaped beam, which provides a wide viewing area.

The distance from the lens to the reflector strip, together with the length of the reflector, serve to define the effective detection area.

Effective Light Curtain Sensor Beam

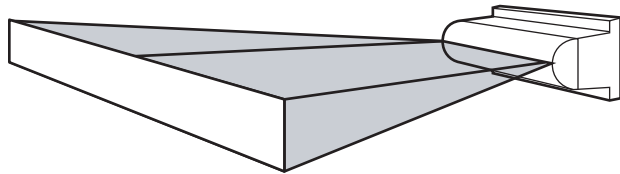

Effective Detection Area Graph

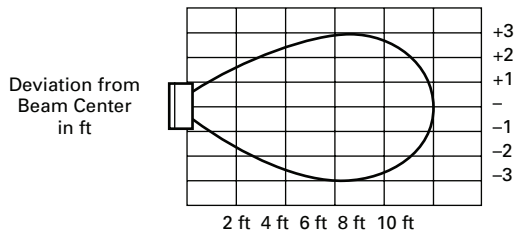

Curtain of Light Beam Profile

Corner Cube Retroreflector and Reflex

In the case of the corner cube reflector, range and excess gain depend upon on reflector quality.

Corner cube reflectors provide the highest signal return to the sensor. Cube style reflectors have 2000-3000 times the reflectivity of white paper.

Corner cube reflectors consist of three adjoining sides arranged at right angles to one another.

Corner Cube Reflector

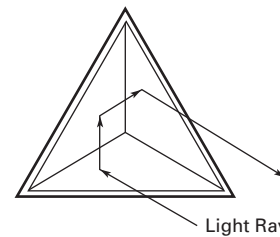

When a ray of light strikes one of the three adjoining sides, the ray is reflected to the second side, then to the third, and then back to its source in a direction parallel to its original course.

Thousands of these cube shapes are molded into a rugged plastic reflector or vinyl material.

Glass Bead

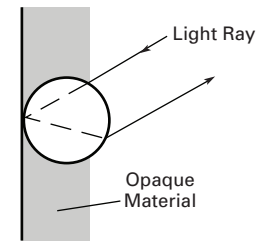

Glass bead retroreflectors are available in tape form for use in dispensers for package coding on conveyors. They are also available in sheet form that can be cut to size. The bead surface is typically rated at 200 to 900 times the reflectivity of white paper.

Only corner cube reflectors can be used with polarized reflex sensors. The light returned from the cube's surface is depolarized with respect to the light it received. Glass bead reflectors cannot be used with polarized retro-reflective sensors.

Contrast

Contrast measures the ability of a photoelectric sensor to detect an object.

The contrast of a sensor is a ratio of the excess gain under light conditions to the excess gain under dark conditions. A ratio of 10:1 is desired.

Contrast is important when a sensor has to detect semi-transparent objects or extremely small objects.

Each mode handles contrast differently.

Thru-Beam and Reflex

These modes are affected by:

- Light transmissivity of an object or surface
- Size of an object in relation to the beam size

Diffuse

This mode is affected by:

- Distance of the object or surface from the sensor
- Color or material of the object or surface
- Size of the object or surface

The ideal application provides infinite contrast ratio of the detection event. This is the case when 100% of the beam is blocked in reflex or thru-beam modes. For diffuse sensing, this occurs when nothing is present. Understanding the contrast ratio is critical when this situation does not exist, such as when detecting semitransparent objects. In some cases, it might be necessary to use a special low-contrast sensor designed for these applications, like a clear object detector version.

Environment

The list below ranks the level of contamination in a range of typical application environments.

As you work your way down the list, the excess gain needed to overcome what's hanging in the air gets higher.

To further complicate matters, with the reflex and thru-beam modes, the source and reflector can be in different locations with different levels of contamination.

For outdoor use, the environment can range from lightly dirty to extremely dirty.

Level of Contamination Ranking

Ranking	Description	Minimum Excess Gain Required
Relatively clean	No dirt buildup on lenses or reflectors	1.5 X
Slightly dirty	Slight buildup of dust, dirt, oil, moisture, etc. on lenses or reflectors. Lenses should be cleaned on a regular schedule.	5 X
Moderately dirty	Obvious contamination of lenses or reflectors. Lenses are cleared occasionally or when necessary.	10 X
Very dirty	Heavy contamination of lenses. Heavy fog, mist, dust, smoke or oil film. Minimal cleaning of lenses takes place.	50 X

In the Workplace

A thru-beam pair is positioned ten inches apart to detect a semi-transparent plastic bottle moving through the sensing zone. But the sensor is not picking up the bottle.

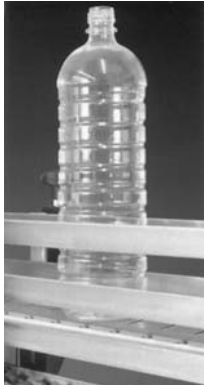

The Right Sensor Type Makes the Difference Between Reliable Sensing and No Sensing at All

Given that the excess gain at that range is 100, and the bottle blocks only 5% of the light energy, the contrast ratio is close to 1 (100/95). This does not meet the advised 10:1 ratio. The thru-beam pair is just too powerful.

Using a focused sensor positioned three to four inches from the bottle changes things. In this detection zone, the excess gain is between 20 and 100. (See Effective Detection Area Graph on **Page V8-T12-31**.)

Review 7

Answer the following questions without referring to the material just presented. Begin the next section when you are confident that you understand what you've already read.

1. Excess gain is a measurement of how much sensing power a photoelectric sensor has available beyond the _____

2. Name the three factors that can affect excess gain.

3. Nearly every diffuse reflective sensor has a unique excess gain curve because nearly every sensor has a unique combination of lenses and beam angles. TRUE FALSE
4. Only corner cube style reflectors should be used with polarized reflex sensors. TRUE FALSE
5. Contrast is not important when sensing semi-transparent targets. TRUE FALSE

Answers to Review 7 are on **Page V8-T12-41**.

Sensor Output Circuits

As we learned earlier, sensors interface to other control circuits through the output circuit. The control voltage type is a determining factor when considering output type. Control voltage types, whether AC, DC or AC/DC, can be categorized as either **load-powered sensor** or **line-powered sensor**.

Load-Powered—Two-Wire Sensors

Load-powered devices are similar to limit switches. They are connected in series with the controlled load. **These devices have two connection points to the circuit and are often referred to as two-wire switches.** The operating current is drawn through the load.

Load Powered/Two-Wire Circuit

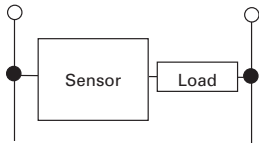

When the switch is not operated, it must draw a minimum operating current referred to as off-state leakage current. Off-state leakage current is also sometimes referred to as residual current. This current is used to keep the sensor electronics active while it “looks” for a target. Residual current is not a problem for loads such as relays, motor starters, etc. (with low impedance). However, loads such as programmable logic controllers (with high impedance) require a leakage current of lower than 2 mA.

Otherwise, an input like a PLC (Programmable Logic Controller) might see the voltage as being an ON signal. Most sensors are 1.7 mA. If a particular PLC requires less than 1.7 mA, a loading resistor is added in parallel to the input to the PLC load. The resistor lowers the current seen by the PLC so it doesn't false trigger.

The current required to **maintain the sensor when the target is present, is called the minimum load or holding current.** This current is about 5 mA depending on the sensor specification. If the current drawn by the load is not high enough, then the sensor cannot operate. Sensors with a 5 mA or less minimum holding current can be used with PLCs without concern.

Line-Powered—Three-Wire Sensors

Line-powered switches derive their power from the line and not through the load. **They have three connection points to the circuit, and are often referred to as three-wire switches.**

Load Powered/Three-Wire Circuit

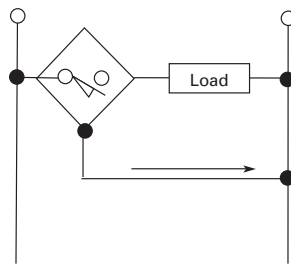

The operating current the switch pulls from the line, is called the burden current. This is typically 20 mA. Because the operating current doesn't pass through the load, it is not a major concern for circuit design.

Two-Wire Sensors

Most sensors are three-wire devices, but some manufacturers offer two-wire devices. They are designed to be easy replacements for limit switches without the need to change wiring and logic.

Because **two-wire switches “steal” their operating power from the load circuit,** there is a voltage drop across the switch when it is on (about 7 – 9 volts in AC powered devices).

Output Types

There are three output types available—Relay, Triac and Transistor.

A relay is a mechanical device that can handle load currents at higher voltages. This allows the sensor to directly interface with motors, solenoids and other inductive loads. **They can switch either AC or DC loads.**

Relays are subject to contact wear and resistance build up, but contact life depends on the load current and the frequency of operations. Due to contact bounce, they can produce erratic results with counters, programmable logic controllers and other such devices, unless the input to those devices are filtered. Because relays are mechanical, they can add 10 to 25 milliseconds to a sensor's **response time.**

Triac Output Circuit

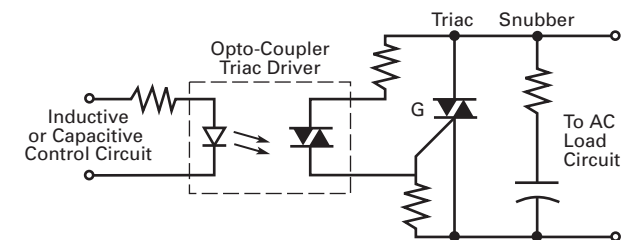

If more than one two-wire switch is wired in series with the load, there is a cumulative voltage drop across the switch. When more than one two-wire switch is connected in parallel with a load, there is a cumulative effect on the leakage current. This increased off-state leakage current could cause a PLC to receive a false ON signal.

For the majority of applications, these limitations cause no problems, or can easily be minimized. **Relay outputs are very commonly used in sensors.**

A triac is a solid-state device designed to control AC current. A triac switch turns on in less than a microsecond when its gate (control leg) is energized, and shuts off at the **zero crossing** of the AC power cycle.

Because a triac is a solid-state device, it is not subject to the mechanical limitations of a relay. Switching response time is limited only to the time it takes the 60 Hz AC power to go through one-half cycle.

AC Power Cycle

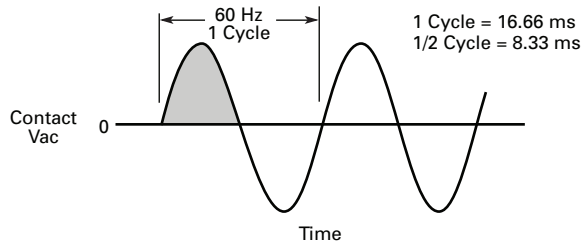

As long as a triac is used within its rated maximum current and voltage specification, life expectancy is virtually infinite. Triac devices used with sensors are generally rated at 2A loads or less, and can be directly interfaced with PLCs and other electronic devices. Triacs do have some limitations in that an inductive load directly connected can false trigger it. A **snubber circuit** can be used to minimize the problem. Shorting the load will destroy a triac, so the device should be short circuit protected to avoid this.

A transistor is a solid-state device designed to control DC current. They are most commonly used in low voltage DC powered sensors

Transistor Output Circuit (Sinking)

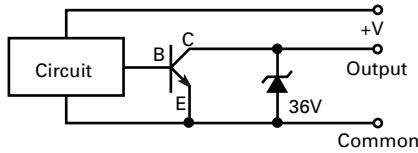

Transistor Output Circuit (Sourcing)

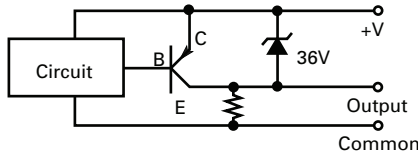

as the output switch. There are two types used, depending on the switching function. One is called **NPN (current sink) open collector**. The output transistor is connected to the negative DC. Current flows from the positive terminal through the load, to the sensor, to the negative terminal. **The sensor "sinks" the current from the load.**

The second type used is called **PNP (Current Source)**. The sensor is connected to the positive DC. Current flows from the positive terminal through the sensor, to the load, to the negative terminal. **The sensor "sources" the current to the load.**

Bilateral FET Device

Photosensors have another output type called a bilateral FET output. This output has many advantages over the other types of outputs:

- Switching of either AC or DC voltages
- Low "OFF-state" leakage
- Extremely fast response time
- Interface direct to TTL and CMOS circuits (for PLCs and industrial computers)
- Does not self-generate line noise

FET is for Field Effect Transistor, and may become the most popular output in the future because of its near ideal operating characteristics.

The voltage applied to the gate (G) controls the conduction resistance between the source (S) and drain (D). Because an FET is a resistive device, it doesn't

develop the fixed voltage drop across its terminals like other solid-state switches. It also does not require any residual or leakage current to keep the electronics powered in the OFF-state.

FET switches are independent of voltage or current phase and can be configured in circuits that will control either AC or DC voltages. For circuits using PLCs, computers or other sensitive devices, FETs are good because they do not generate any switch induced line noise like relay and triac switches.

Like the other solid-state outputs, they cannot tolerate line spikes or large inrush currents. In the illustration above, a transorb is used to protect the FET from voltage spikes and dissipate the energy as heat.

Bilateral FET Device (AC/DC Switch)

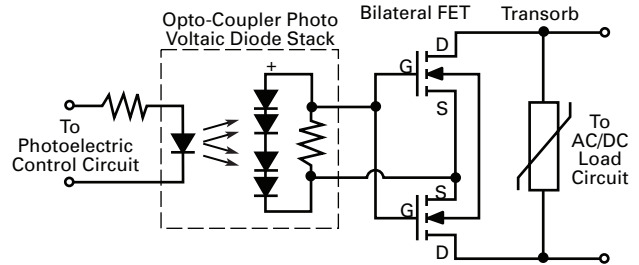

Output Configurations

Single Output

As in other control devices, several output configurations are available for sensors. Fixed single outputs, either 1NO or 1NC, are very

common and NO is the most common. Fixed single output sensors cannot change configuration to the other circuit.

Single Output

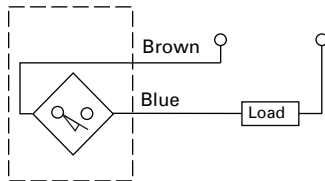

Programmable Output

A **programmable output** sensor has one output, NO or NC, depending on how the output is wired when it's installed. Sometimes the output configuration is

selected using a switch. On photoelectric sensors this is called a light/dark switch. This allows you to program the sensors output normally open (NO) or normally closed (NC).

Programmable Output

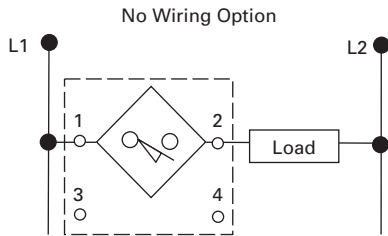

Accessory Considerations

The choice of control circuit, of using single, programmable or complementary outputs are dependent upon:

- Voltage available—Does the control circuit have provisions for supplying DC? Some control circuits have interfacing circuitry for DC sensors even if the main control voltage source is AC.
- Control circuit current requirements—If the circuit requires a current greater than the rating on the sensor, an interposing relay can be used.

Complementary Output

A **complementary output** sensor has two outputs, 1NO and 1NC Both outputs change state simultaneously when the target enters or leaves the sensing field.

The output logic for the normally open and normally closed contact configurations for an inductive proximity sensor is shown in the table below.

Complementary Output

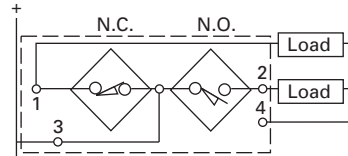

Output Logic

Output Configuration	Target	Output State
NO	Absent	Non-conducting (OFF)
	Present	Conducting (ON)
NC	Absent	Conducting (ON)
	Present	Non-conducting (OFF)

- Connected logic device—Probably the most important factor for sensor circuit and output configuration is the device to which the sensor is to be connected. What type of input the PLC, counter, relay, etc. can accept is the determining factor for which sensor output is chosen.

Other considerations are whether the sensor will need LED indication of its status and whether there is short circuit protection, reverse polarity protection or wire termination needed.

- Application output requirements—While NO is the most commonly used, certain applications may require the circuit logic provided by NC, or even the complementary configured sensors.
- Switching speed requirements—For applications requiring high speed, such as counting, DC sensors may be required. AC circuits are limited by operations per second (because of the AC sine wave), and are typically slower than DC.

Switching Logic

Output Logic Functions

The outputs of two or more sensors can be wired together in series (and) and parallel (or) to perform logic functions. Factors that need to be taken into consideration, however, are excessive leakage current or voltage drop and inductive feedback with line powered

sensors. For these reasons, series and parallel connections for logic functions is not commonly done. It is usually easier to connect direct to a PLC's inputs and perform the logic functions through the PLC program.

Output Response Time and Speed of Operation

Photoelectric, inductive and capacitive sensors can operate considerably faster than a limit switch, making them better choices for high-speed operations such as counting or sorting. The time it takes to respond, its speed of operation, is based on several factors. Let's take a moment to consider them.

When a system is first powered up, the sensor cannot operate until the electronics are "powered up." This is referred to as **time before availability**.

For AC sensors, this delay is typically from 35 milliseconds up to as high as 100 milliseconds. For a DC sensor, the delay is typically 10 milliseconds.

Response Time and Release Time for an Inductive Proximity Sensor

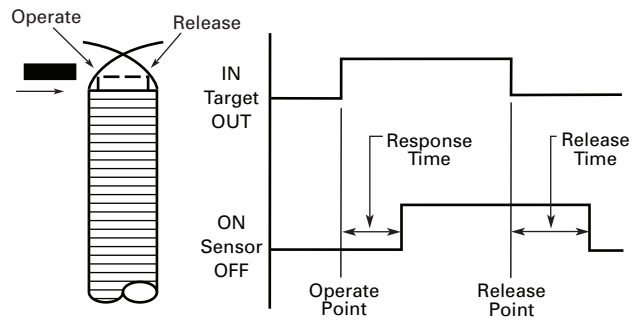

Similarly, when the target leaves the sensing field there is a slight delay before the switch is restored to the OFF state. This is referred to as the **release time**. An AC sensor typically releases in one cycle (16.66 milliseconds) and DC devices usually in 1 millisecond, or less.

In order to properly achieve high-speed operations, there are some basic principles that need to be applied. In addition to the sensor's response and release times,

there is a similar delay for the load to operate. This is called the **load response time**. The total times combined are referred to as **system response time**. Similarly, there are **load release time** and **system release time** for when the target exits the sensing field. In order to ensure reliability and repeatability, the target must stay in the sensing field long enough to allow the load to respond. This is referred to as **dwell time**.

Time Delay Before Availability

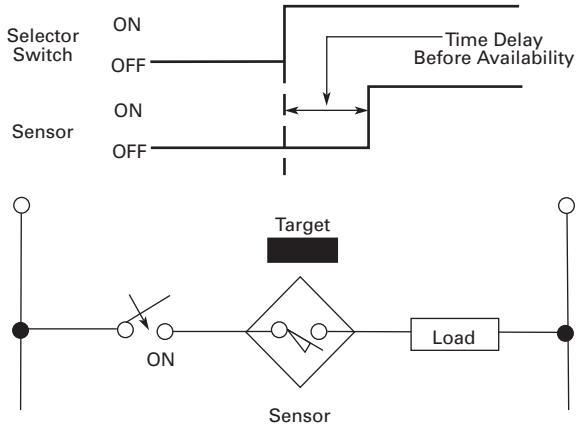

Once the target enters the sensing range and the detector causes the output to change state, a certain amount of time elapses. This

is called **response time**. For an AC sensor this is usually less than 10 milliseconds. DC devices respond in 1 millisecond or less.

Output Timing Modes

When a sensor is operated without a logic module, the output is generated for the length of time the object is detected.

Some sensors are available with a logic module to allow setting timing functions.

Let's look at each logic function, as shown in the following illustrations.

Logic Functions

ON Delay Logic

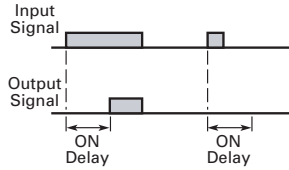

This allows the output signal to turn on only after the target has been detected for a predetermined period of time. The output turns off as soon as the target passes out of range.

ON delay is useful in bin fill or jam detection because the sensor will not false trigger on the normal flow of objects going past.

ON/OFF Delay Logic

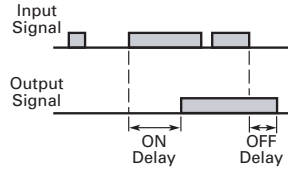

This logic function combines the ON delay logic and OFF delay logic—the output is only generated after the target has been detected for a set period of time, and will remain on after the target is no longer detected for a set period of time.

The mode smooths the output of the sensor for applications such as jam detection, fill level detection and edge guide.

Retriggerable One-Shot Logic

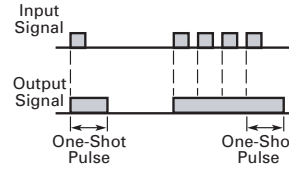

This mode generates an output of predetermined length whenever an object is detected. The sequence restarts each time an object is detected, and will remain triggered as long as a stream of objects are detected before the one-shot times out. A retriggerable one-shot is useful in detecting underspeed conditions on conveyor lines.

Underspeed Detection Logic

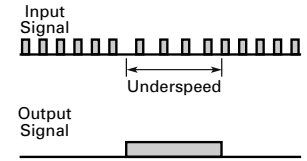

Operates identically to a retriggerable one-shot. It detects speeds that fall below a certain predetermined level.

In addition, the underspeed detector has a built-in latch feature that shuts the system down completely when the speed slows to a preset level. This prevents the one-shot from retriggering once it times out, eliminating erratic switching while the motor is winding down.

OFF Delay Logic

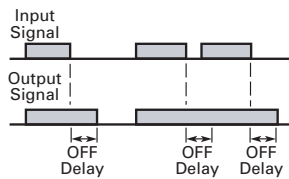

For applications where there is a problem with signal loss in the system, this function turns the output on when the object is detected, and then holds the ON signal for a set period of time after the object is no longer detected.

One-Shot Logic

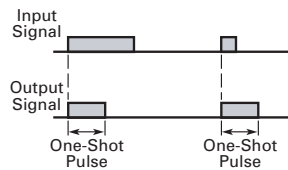

This type of logic generates an output of a set length no matter how long an object is detected. A one-shot can be programmed to trigger on the leading or trailing edge of a target. A one-shot ON signal must time out before it can detect another input.

This logic is useful in applications that require an output of specified length.

Delayed One-Shot Logic

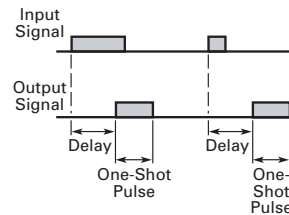

Combines on delay and one-shot logic. The one-shot feature is delayed for a predetermined period of time after an object is detected. A delayed one-shot is useful where the photoelectric control cannot be mounted exactly where the action is taking place. This includes applications like paint booths, high temperature ovens or drying bins.

Underspeed/Overspeed Detection Logic

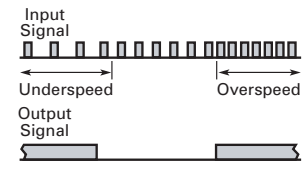

Detects both overspeed and underspeed conditions. The detector is set to count a certain number of objects in a specified amount of time. If the system operates either at a higher or lower rate, an output is generated.

In the Workplace

Paper breaks in a web printing press can result in time-consuming manual re-threading of the paper if the break is not immediately detected. A photoelectric sensor can detect this condition instantly, and do it in this tight space

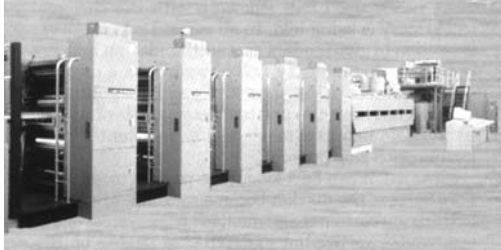

A Photoelectric Sensor Minimizes Downtime for this Printing Press

High excess gain and sharp optical cut-off of a diffuse mode Perfect Prox ensure that background machinery is ignored. Meanwhile, paper is detected, regardless of texture, color or printing on it.

Review 8

Answer the following questions without referring to the material just presented.

Match the output circuit reference to its definition.

- | | |
|--|-------------------------------|
| 1. The current required to maintain the sensor when a target is present _____ | A. Residual current (leakage) |
| 2. Having three connections (three-wire) to the circuit _____ | B. Burden current |
| 3. The operating current the switch pulls from the line _____ | C. Load-powered |
| 4. Having two connections (two-wire) to the circuit _____ | D. Line-powered |
| 5. The initials designating a transistor output that sinks current from the load are _____ | |
| 6. The initials designating a transistor output that sources current to the load are _____ | |

In questions 7 through 13, match the term used to describe the following:

- | | |
|---|-----------------------------|
| 7. The delay of a sensor when the system is first powered up _____ | A. Release time |
| 8. The period during target sensing and the detector causing output to change to ON state _____ | B. Dwell time |
| 9. The period during target exiting the sensing range and the output changing to OFF state _____ | C. ON delay logic |
| 10. The period during which the target must stay in range to allow the load to respond _____ | D. One-shot logic |
| 11. Logic module that allows output signal only after target detection for a set period of time _____ | E. Time before availability |
| 12. Logic module that allows output signal to be held ON for a set period of time _____ | F. OFF delay logic |
| 13. Logic module that allows output signal to be a specific length regardless of target physical size or detection timing _____ | G. Response time |

Answers to Review 8 are on **Page V8-T12-41**.

Enclosure Ratings

NEMA Non-Hazardous Locations

Type	Description
1	For indoor use, primarily to provide a degree of protection against contact with the enclosed equipment.
3	Intended for outdoor use, primarily for a degree of protection against windblown dust, rain, sleet and external ice formation.
3R	For outdoor use, primarily to provide a degree of protection against falling rain, sleet and external ice formation.
4	For indoor and outdoor use, primarily to provide a degree of protection against wind blown dust and rain, splashing water and hose directed water.
4X	Intended for indoor or outdoor use, primarily to provide a degree of protection against corrosion, windblown dust and rain, splashing water and hose directed water.
6	Intended for indoor or outdoor use, primarily to provide a degree of protection against the entry of water during occasional temporary submersion at a limited depth.
6P	Intended for indoor or outdoor use, primarily to provide a degree of protection against the entry of water during prolonged submersion at a limited depth.
12	Intended for indoor use, primarily to provide a degree of protection against dust, falling dirt and dripping non-corrosive liquids.
13	Intended for indoor use, primarily to provide a degree of protection against dust, spraying of water, oil and non-corrosive coolant.

NEMA Hazardous Locations

Type	Description
Type 7	For indoor use, within conditions of Class I and Groups shown, to withstand and contain an internal explosion of specified gases, or to contain an explosion sufficiently so as not to ignite an explosive gas-air mixture in the surrounding atmosphere.
Class I	
Group A	Acetylene
Group B	Hydrogen, butadiene, ethylene oxide, propylene oxide
Group C	Carbon monoxide, ether, ethylene, hydrogen sulfide, morpholine, cyclopropane
Group D	Gasoline, benzene, butane, propane, alcohol, acetone, ammonia, vinyl chloride
Type 9	For indoor use, within Class II and Groups shown below conditions, to withstand and contain an internal explosion of specified dusts, or to contain an explosion sufficiently so as not to ignite an explosive dust-air mixture in the surrounding atmosphere.
Class II	
Group E	Metal dusts
Group F	Carbon black, coke dust, coal
Group G	Grain dust, flour, starch, sugar, plastics

IEC Ratings

IEC Environmental Enclosure Ratings

Examples of Designations

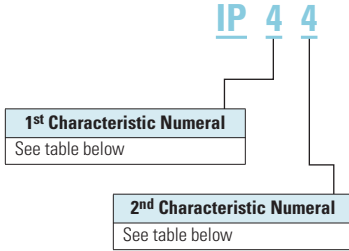

An enclosure with this designation is protected against the penetration of solid objects greater than 1.0 mm and against splashing water.

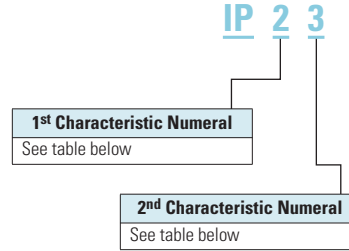

An enclosure with this designation is protected against the penetration of solid objects greater than 1.2 mm and against rain.

Index of Enclosure Ratings—IEC

1st Characteristic Numeral

Numeral	Description
Protection against contact and the penetration of solid bodies	
0	Not protected
1	Protection against solid objects greater than 50 mm.
2	Protection against solid objects greater than 12 mm.
3	Protection against solid objects greater than 2.5 mm.
4	Protection against solid objects greater than 1.0 mm.
5	Dust protected
6	Dust-tight

2nd Characteristic Numeral

Numeral	Description
0	Not protected
1	Protection against dripping water
2	Protection against dripping water when tilted up 15 degrees
3	Protection against rain
4	Protection against splashing water
5	Protection against water jets
6	Protection against heavy seas
7	Protection against the effects of immersion
8	Protection against immersion

Review Answers**Review 1 Answers**

1. Presence, absence
2. Limit Switch, Proximity Sensor, Photoelectric Sensor
3. Electromechanical
4. Inductive proximity
5. Photoelectric

Review 2 Answers

1. Operating Head, Switch Body, Receptacle
2. C
3. F
4. D
5. A
6. E
7. B
8. True

Review 3 Answers

1. a. 2 b. 4 c. 3 d. 1
2. C
3. A
4. D
5. B
6. True

Review 4 Answers

1. Ferrous
2. True
3. False
4. True
5. True
6. False

Review 5 Answers

1. True
2. Sensor (or Dielectric), Oscillator Circuit, Detector Circuit, Output Circuit
3. True
4. False
5. False
6. True

Review 6 Answers

1. Thru-Beam. Reflex (or Retro-Reflective), Diffuse Reflective, Background Rejection (or Perfect Prox)
2. D
3. C
4. B
5. A

Review 7 Answers

1. Power required
2. Target size, color, texture; Contamination (dust, humidity, debris); Application (distance, background, reflectivity)
3. True
4. True
5. False

Review 8 Answers

1. A
2. D
3. B
4. C
5. NPN
6. PNP
7. E
8. G
9. A
10. B
11. C
12. F
13. D